

# Centre for Archaeological Fieldwork

School of Geography, Archaeology and Palaeoecology, QUB

**CAF Data Structure Report: No. 111**

**Excavations at Dunluce Castle, Co. Antrim**

Andrew Gault and Grace McAlister

**VOLUME 2: FIGURES AND PLATES**

ANT 002:003 & ANT 002:008



On behalf of





## **EXCAVATIONS AT DUNLUCE CASTLE, CO. ANTRIM**

Excavations carried out on behalf of  
The Northern Ireland Environment Agency (NIEA): Built Heritage

**Directed by Andrew Gault and Grace McAlister**

Report by

***Grace McAlister***

*gmcAlister02 @qub.ac.uk*

The Centre for Archaeological Fieldwork  
School of Geography, Archaeology and Palaeoecology  
Queen's University  
Belfast, BT7 1NN

CAF Data Structure Report No. 111

SMR: ANT002:003 and ANT 002:008

Excavation Licence: AE/14/78

*30<sup>th</sup> October 2014*

**VOLUME 2:      FIGURES AND PLATES**

# CONTENTS

## VOLUME 2

FIGURES	1
PLATES	71



FIGURES



Figure 1: Plan showing the five areas of archaeological potential – Area C, Area D, Area E, Area G and Area T (produced by Dr Siobhan McDermott - CAF)



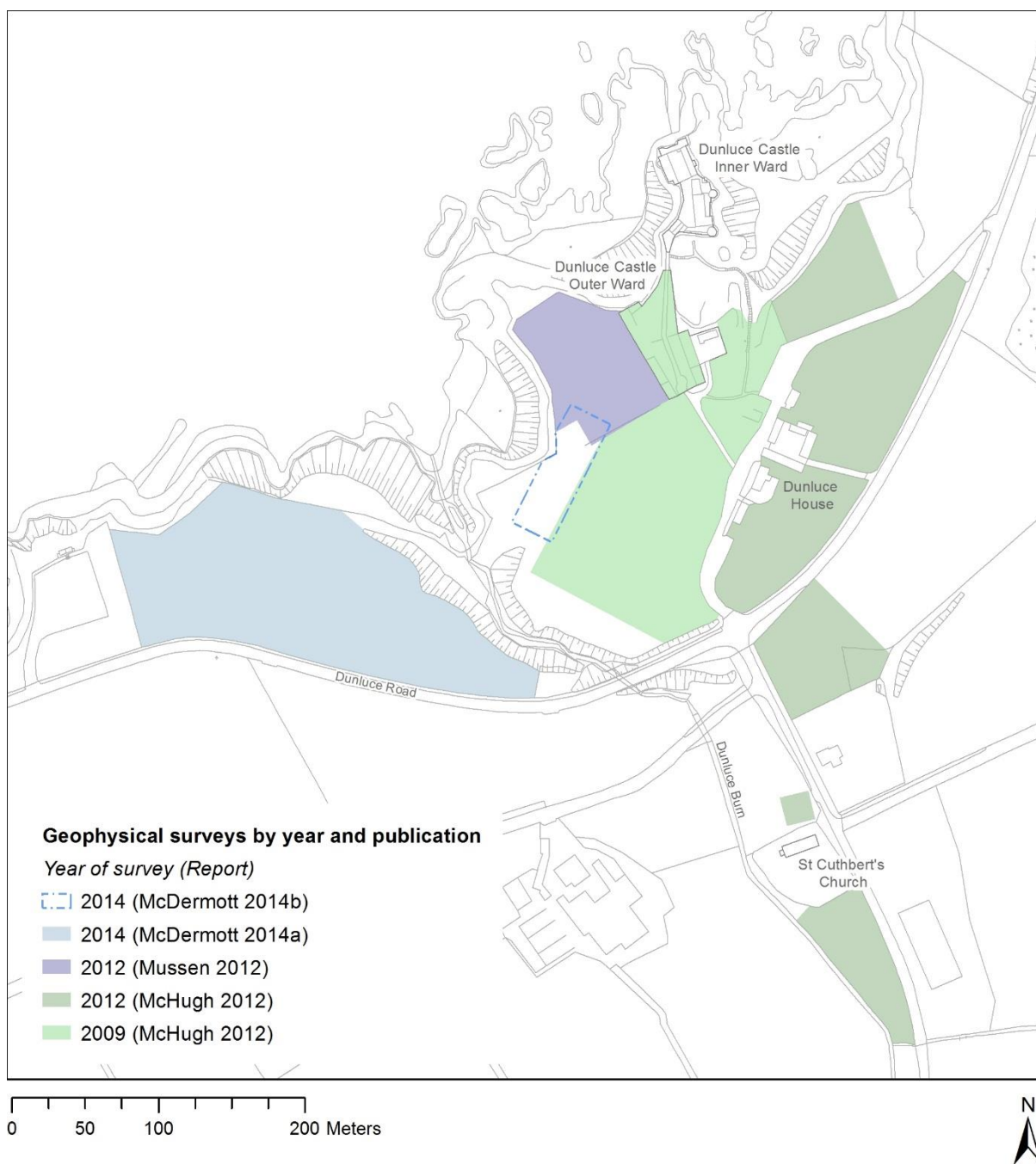

Figure 2: Plan showing the extent of archaeological investigations carried out at Dunluce Castle and the surrounding environs, including the 2008-2012 research and the 2014 excavation and geophysical survey (produced by Dr Siobhan McDermott – CAF)

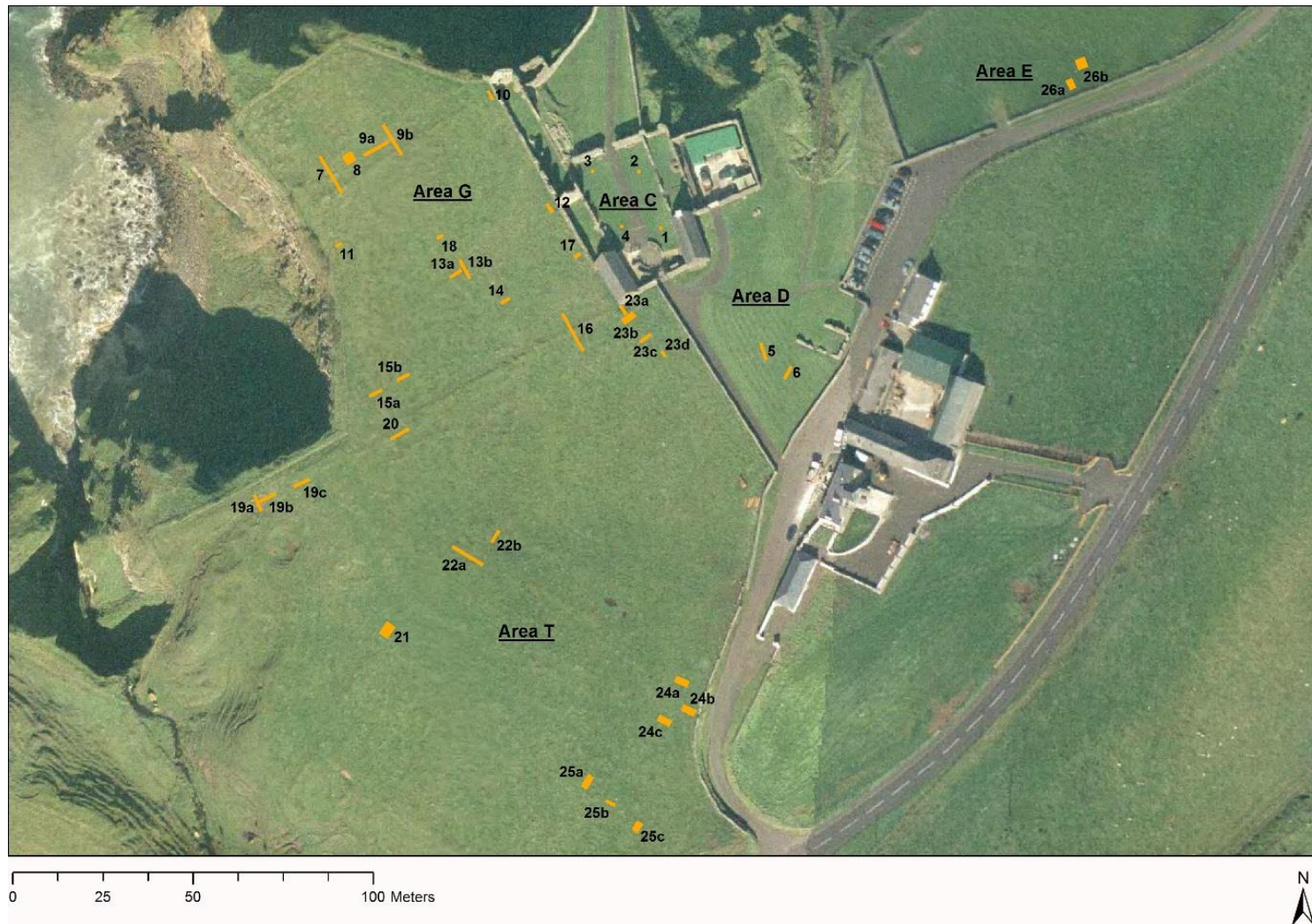

Figure 3: Plan showing the original trenches outlined in the Research Design (*produced by Dr Siobhan McDermott – CAF*)

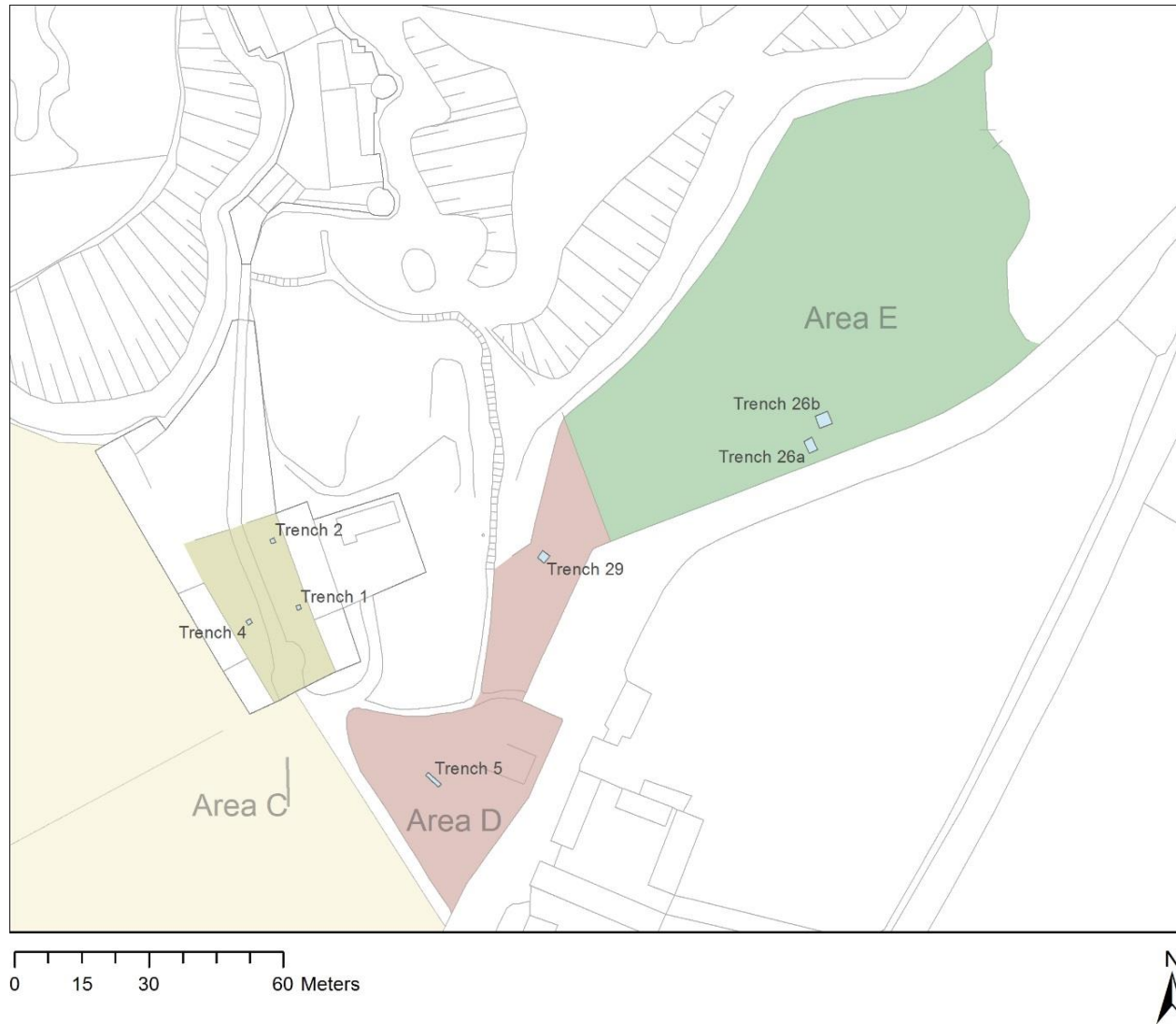
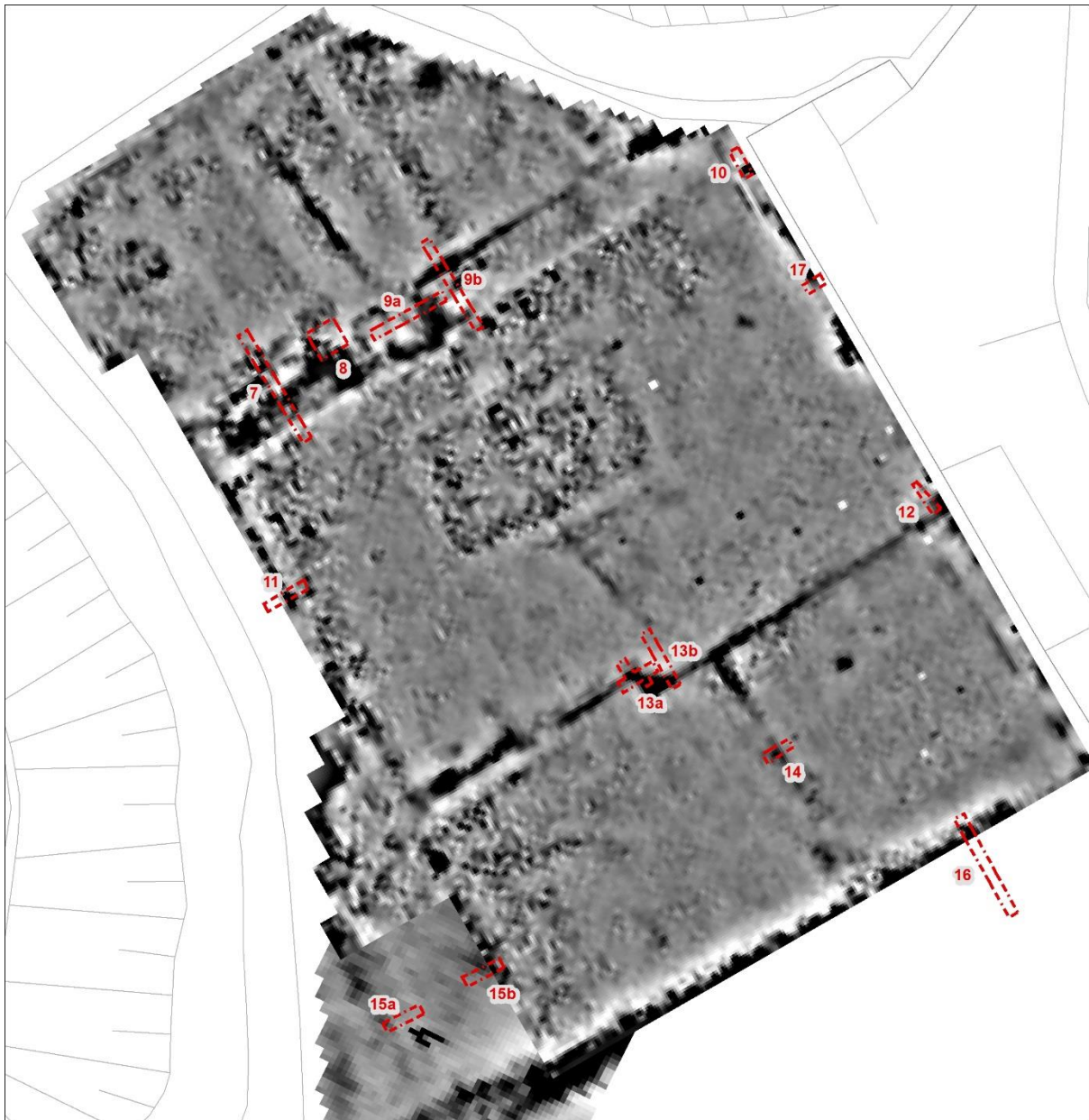

Figure 4: Plan showing the location of trenches excavated in Area C, Area D and Area E (produced by Dr Siobhan McDermott – CAF)





Figure 5: Map showing the location of trenches excavated in Area G (produced by Dr Siobhan McDermott – CAF)



0 5 10 20 Meters



**Legend**

**Dunluce Gardens processed electrical resistance survey**

High : 15.04  
Low : -11.38n Ohm

 Excavation trenches

**Supplementary processed electrical resistance survey**

High : 6.17  
Low : -3.15 Ohm

Figure 6: Plan showing the location of the trenches excavated in Area G in relation to the geophysical survey data (produced by Dr Siobhan McDermott – CAF, after Mussen 2012)



Figure 7: Plan showing the location of trenches excavated in Area T (produced by Dr Siobhan McDermott – CAF)



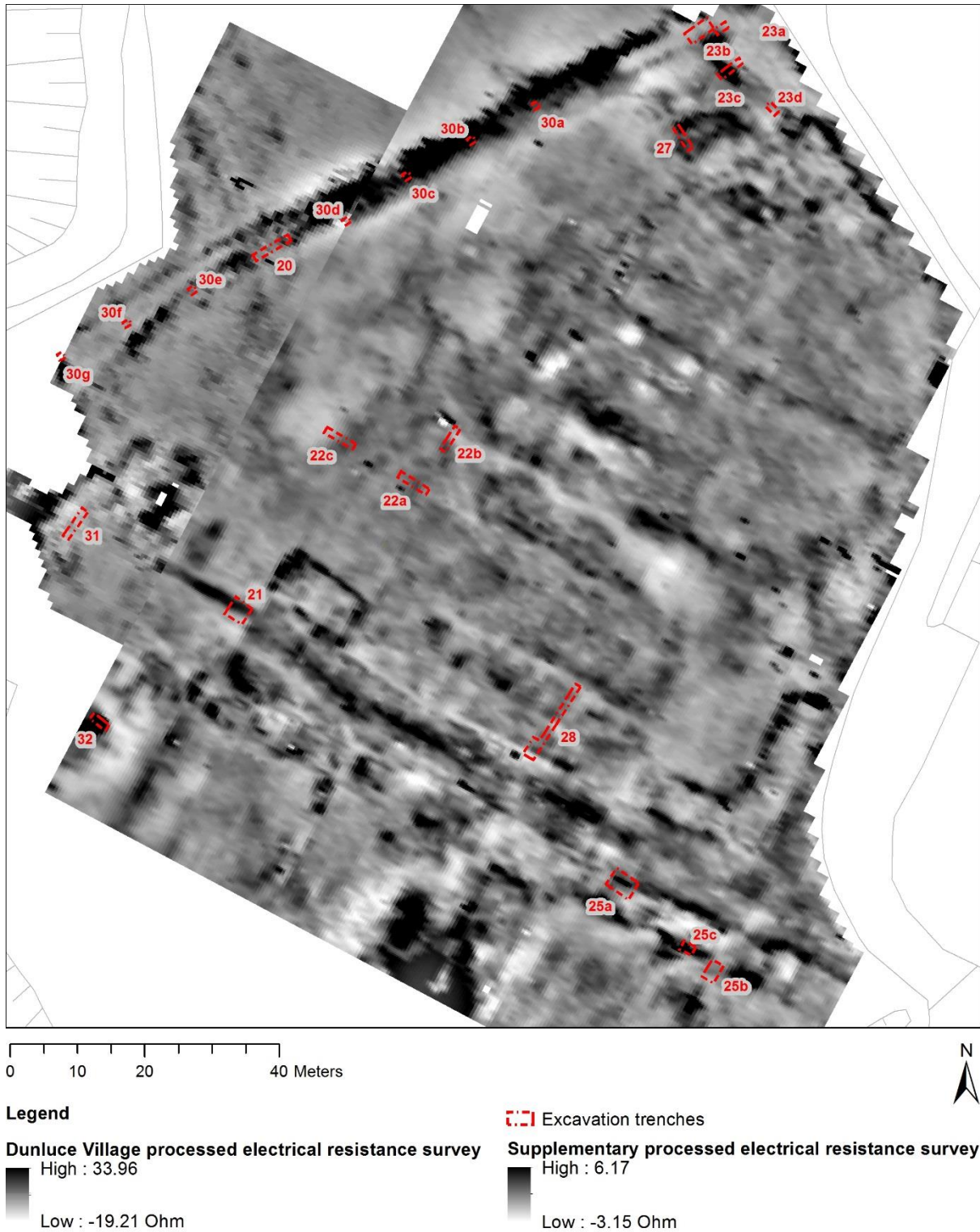

Figure 8: Plan showing the location of the trenches excavated in Area T in relation to the geophysical survey data (produced by Dr Siobhan McDermott – CAF, after McHugh 2012)

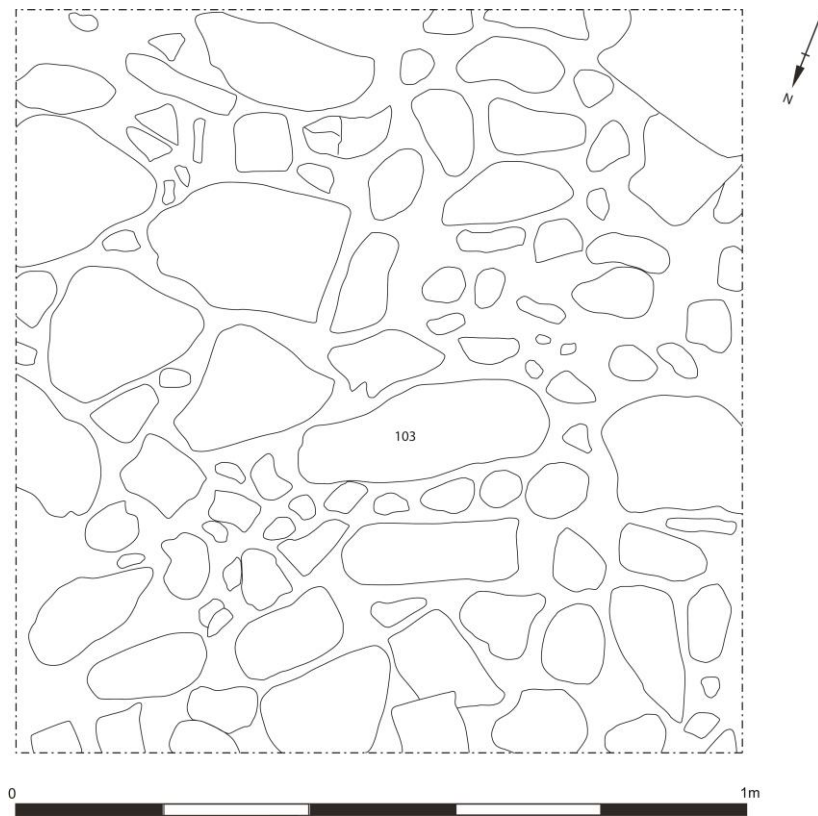

Figure 9: Post excavation plan of Trench 1

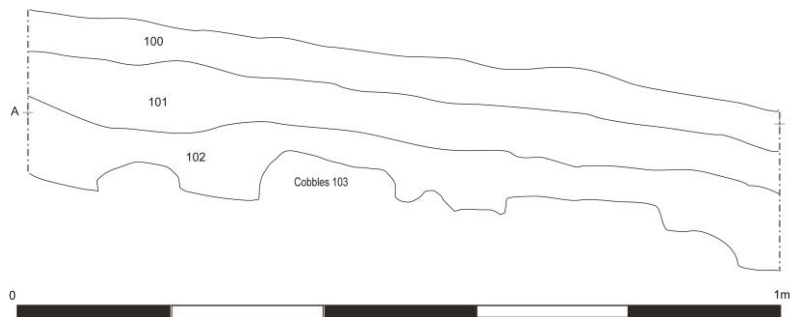

Figure 10: East facing section of Trench 1

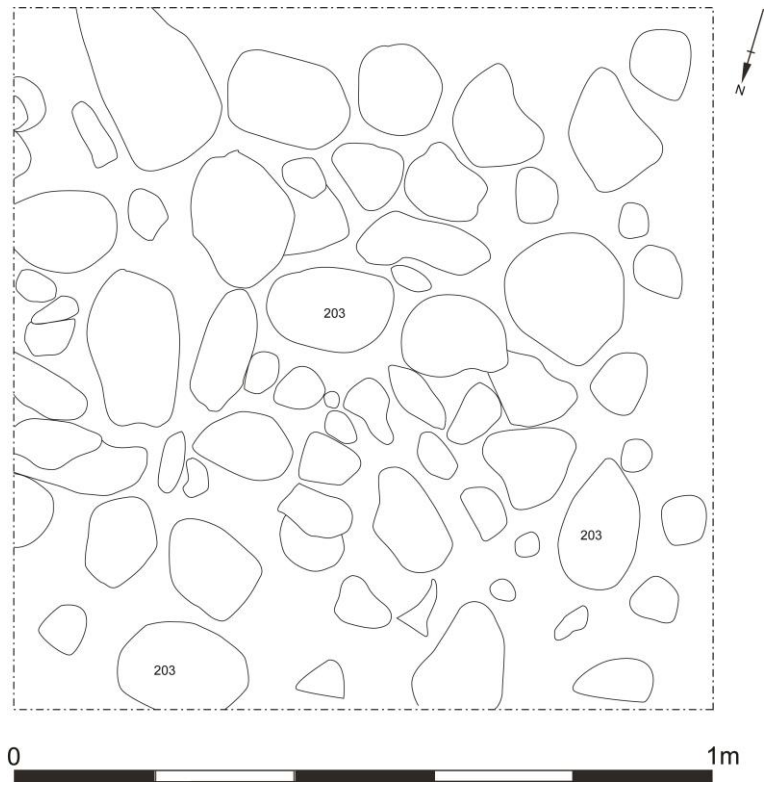

Figure 11: Post excavation plan of Trench 2

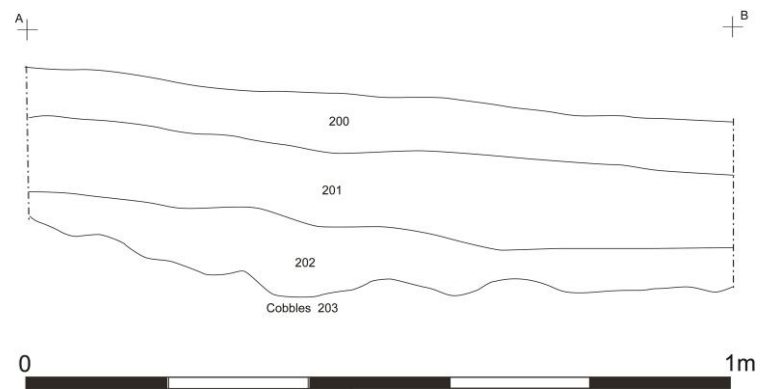

Figure 12: West facing section of Trench 2



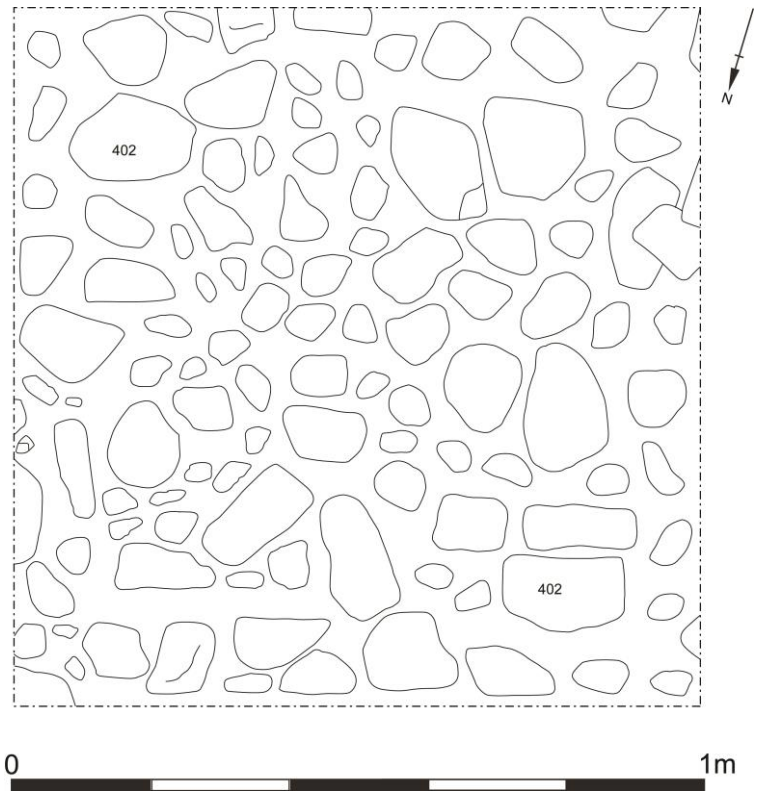

Figure 13: Post excavation plan of Trench 4

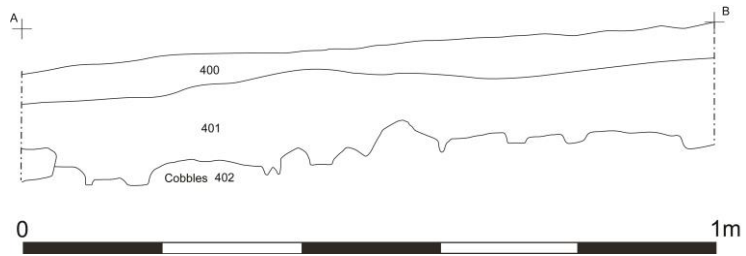

Figure 14: West facing section of Trench 4

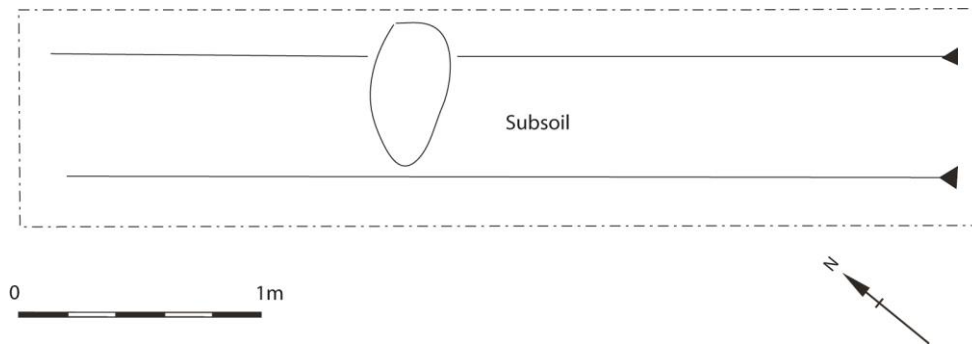

Figure 15: Post excavation plan of Trench 5

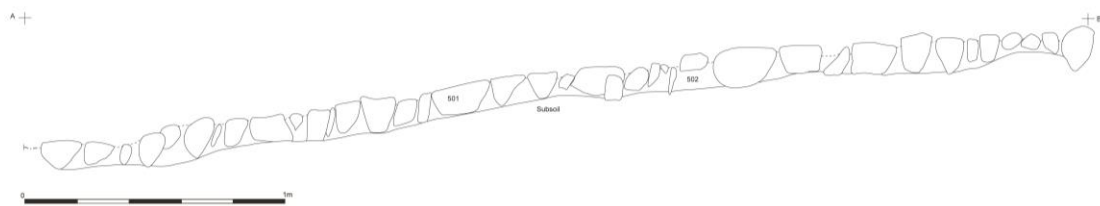

Figure 16: West facing section of Trench 5

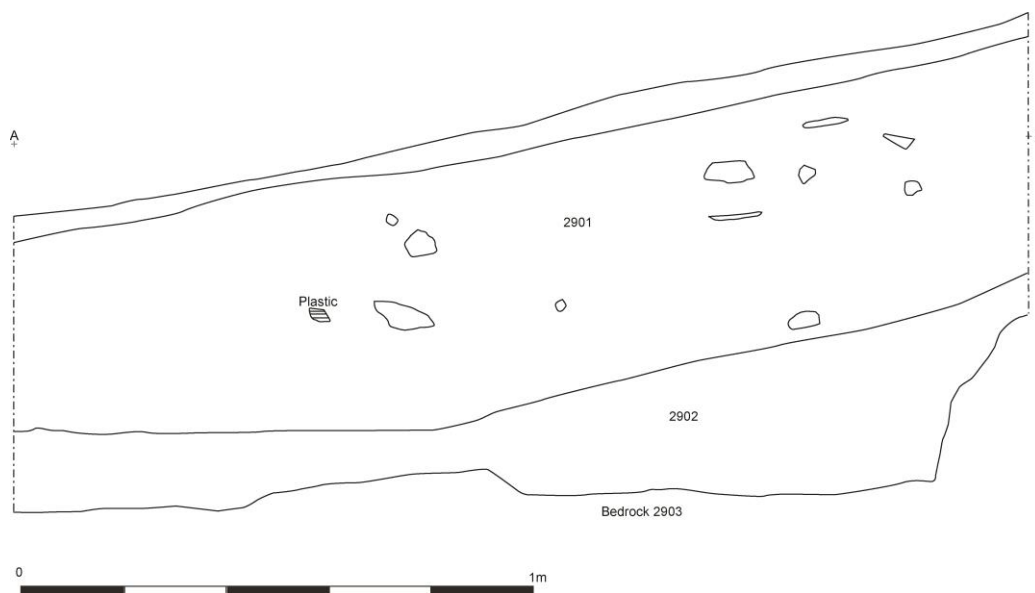

Figure 17: East facing section of Trench 29

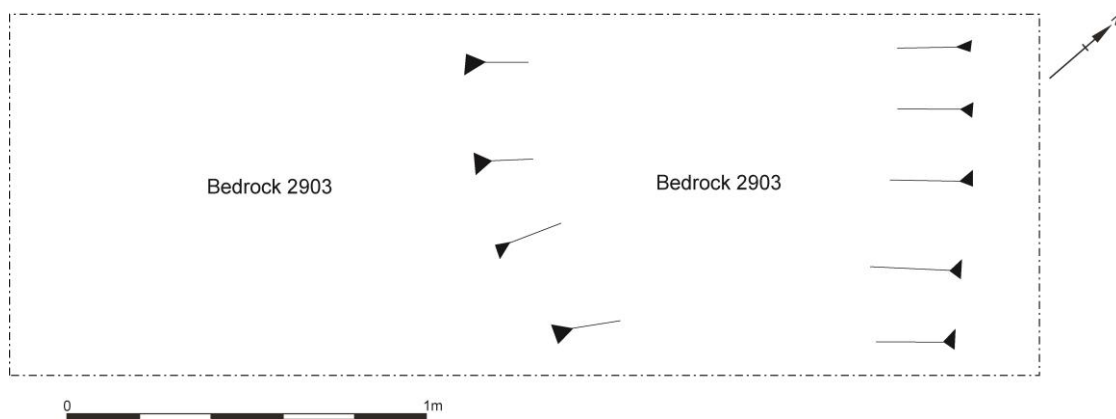

Figure 18: Post-excavation plan of Trench 29

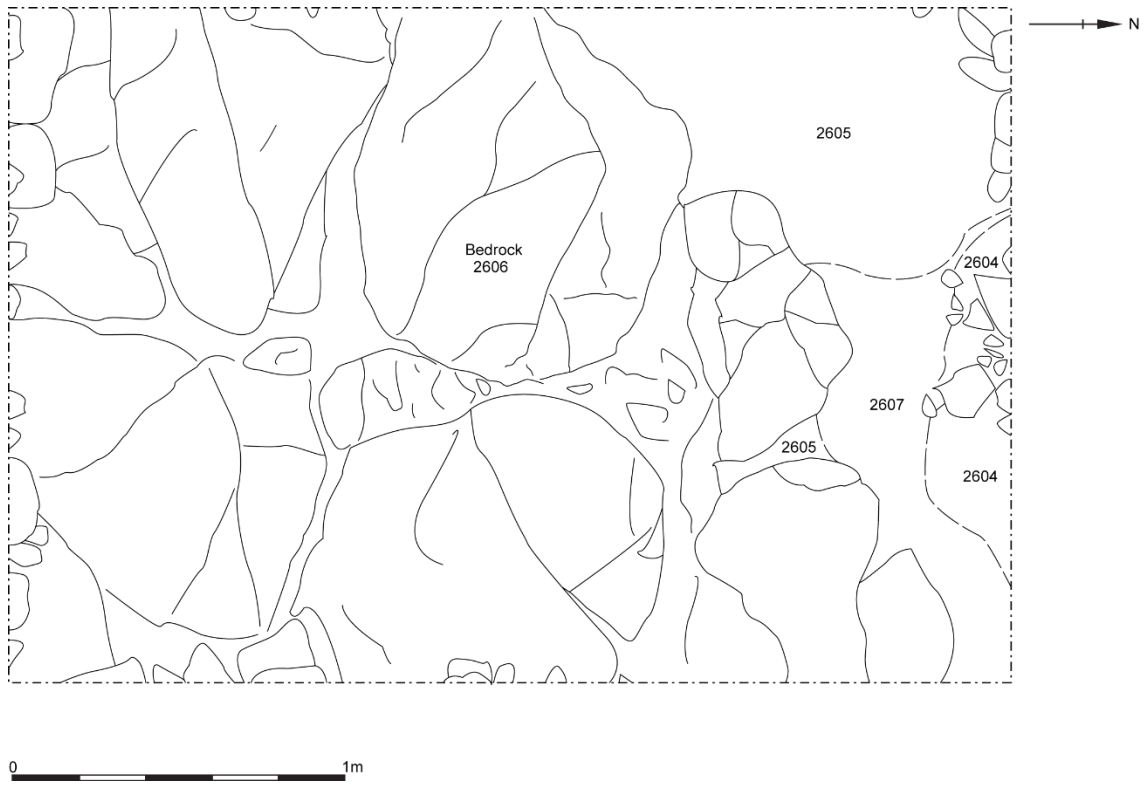

Figure 19: Mid-excavation plan of Trench 26a

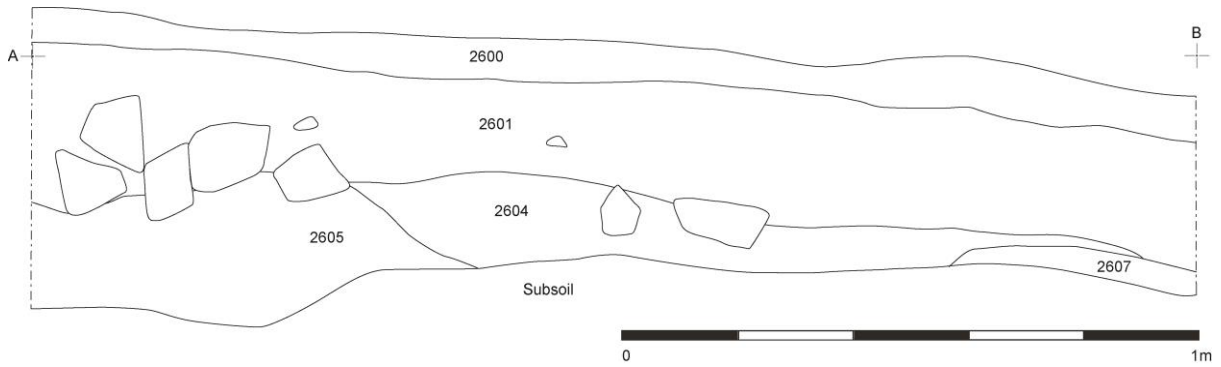

Figure 20: South facing section of Trench 26a

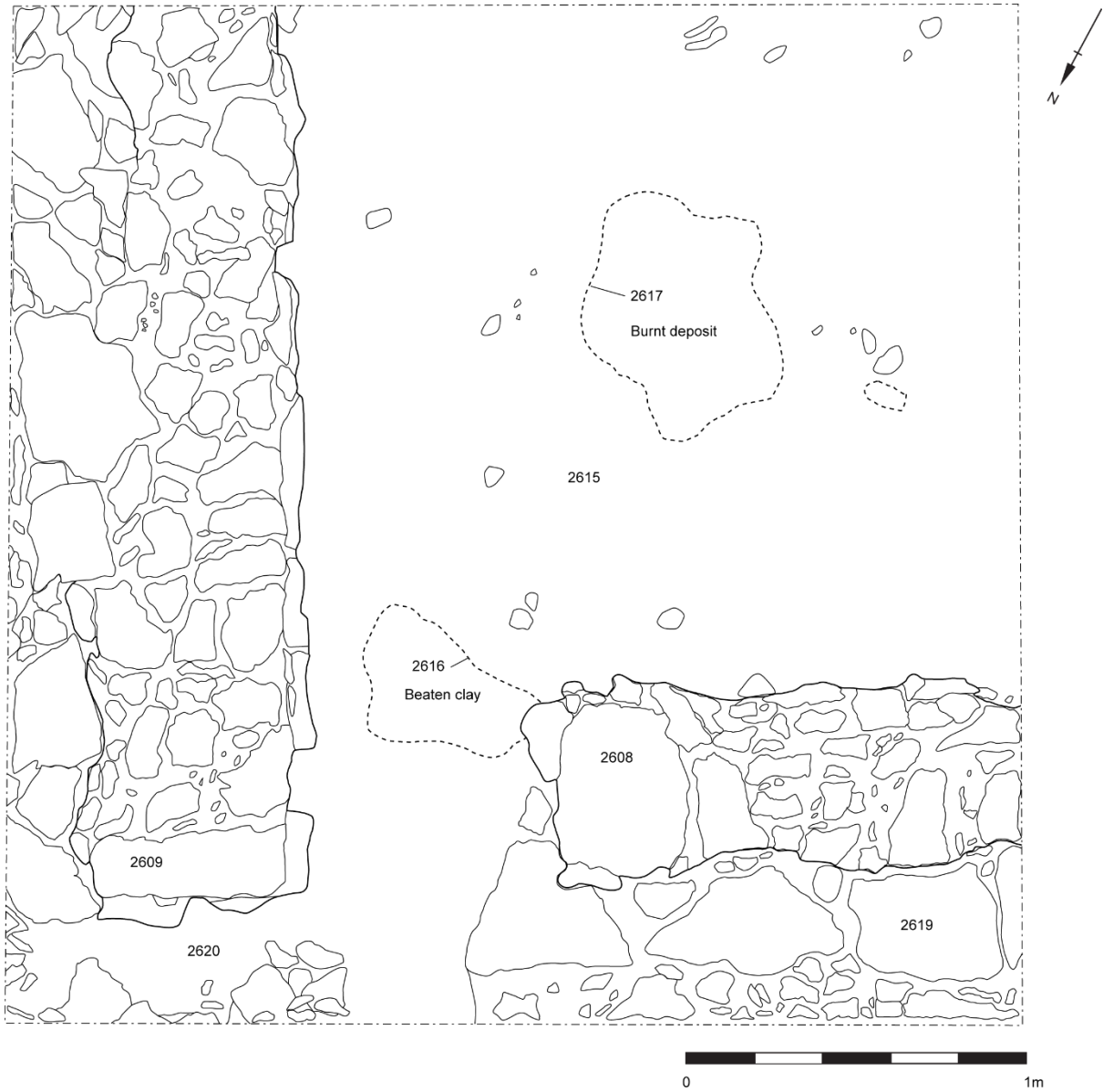

Figure 21: Post-excavation plan of Trench 26b



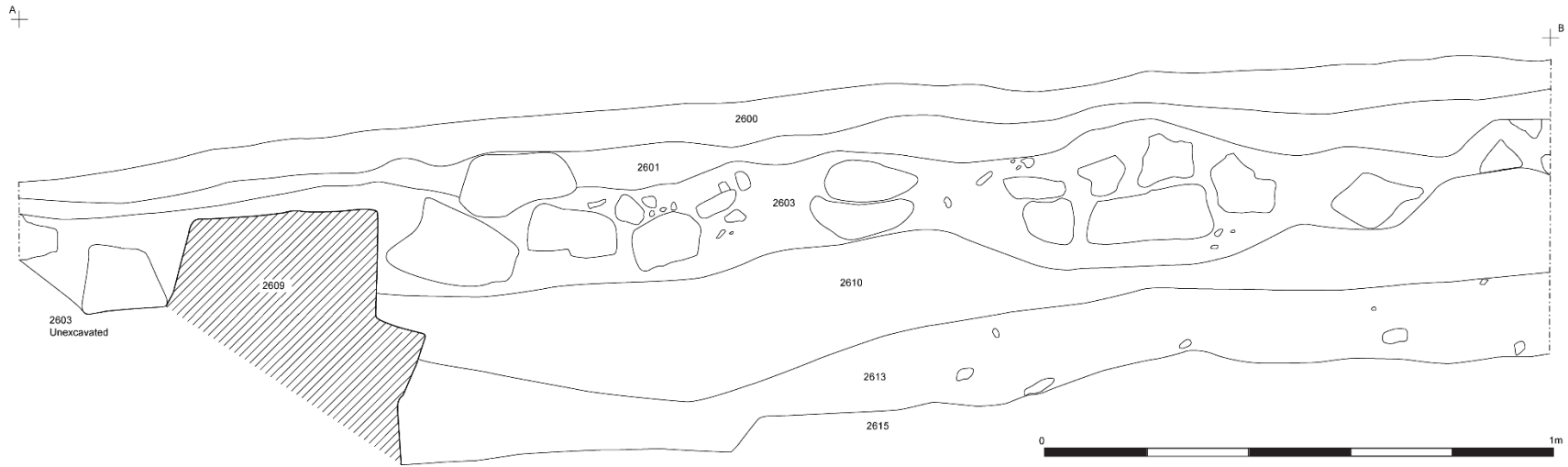

Figure 22: North facing section of Trench 26b

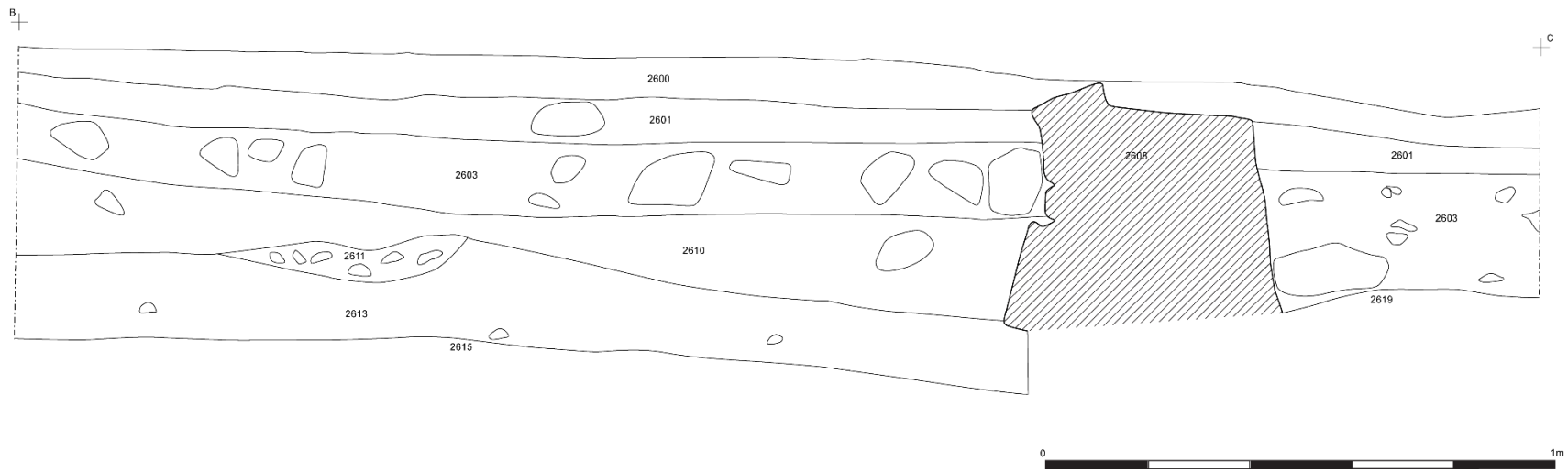

Figure 23: East facing section through Trench 26b

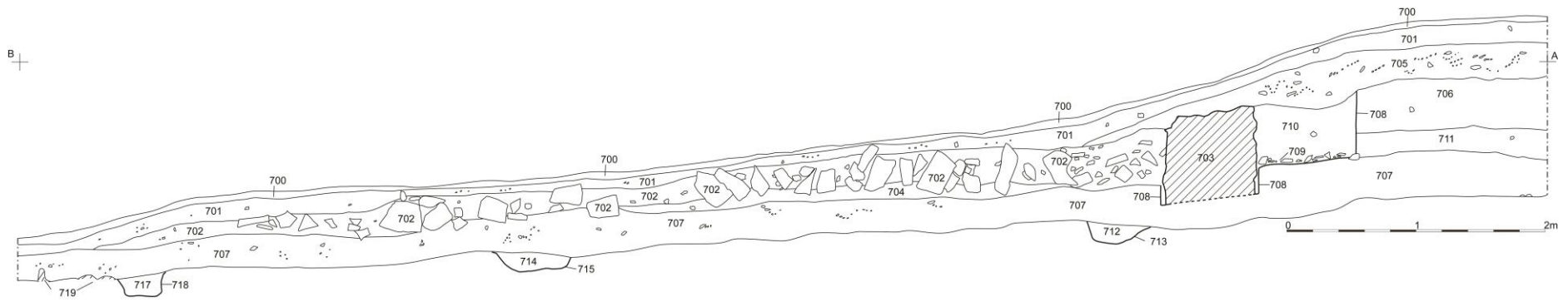

Figure 24: West facing section of Trench 7

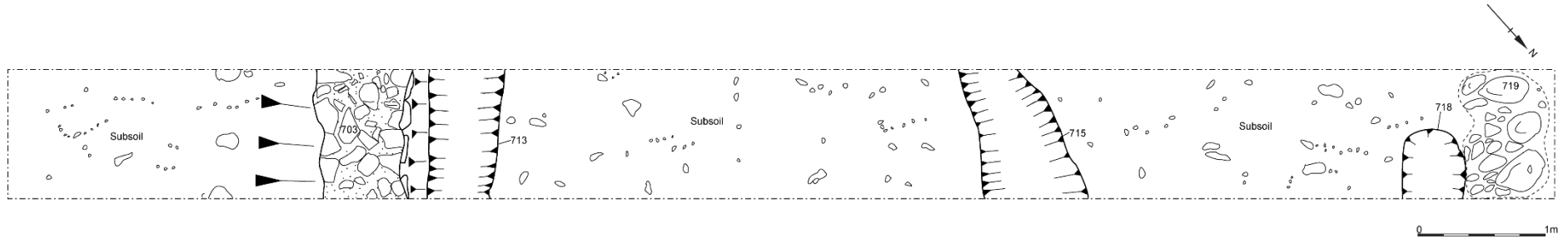

Figure 25: Post-excavation plan of Trench 7

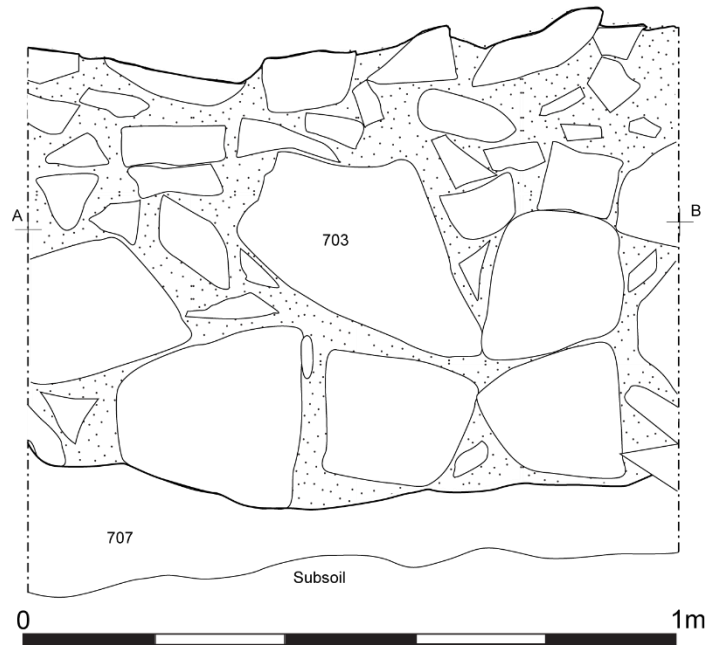

Figure 26: Trench 7, south facing elevation of wall 703

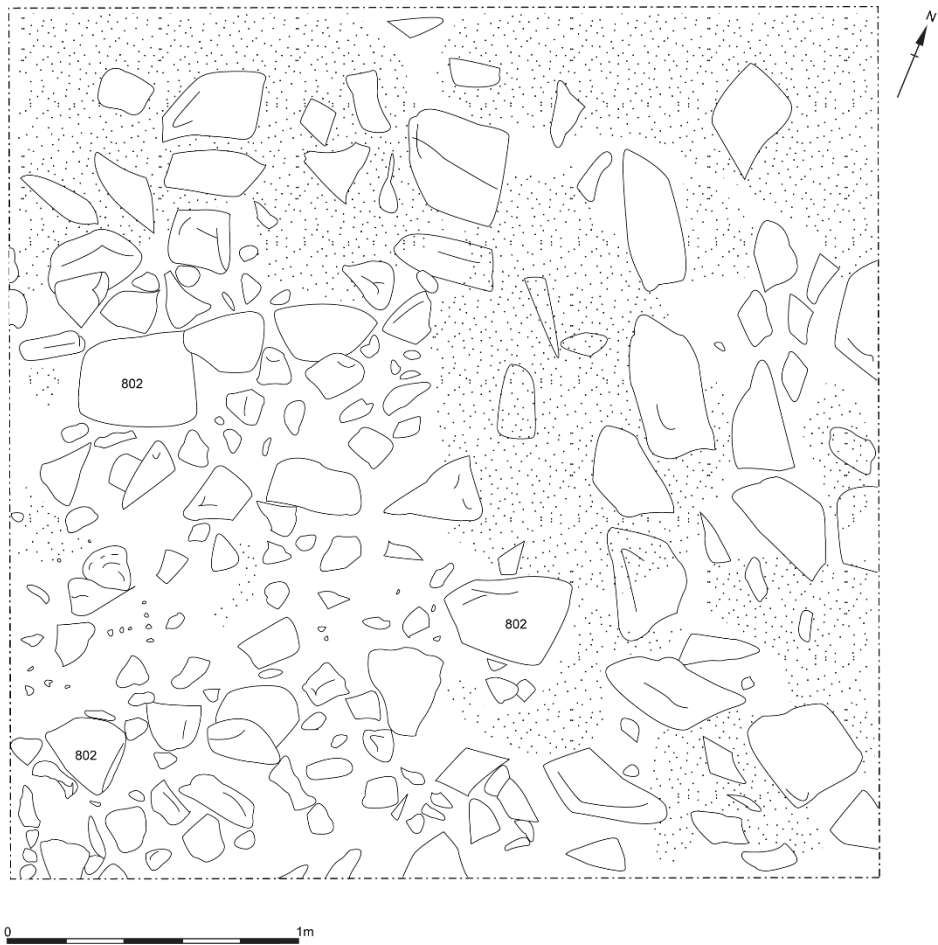

Figure 27: Mid-excavation plan of Trench 8 showing stone collapse, 802

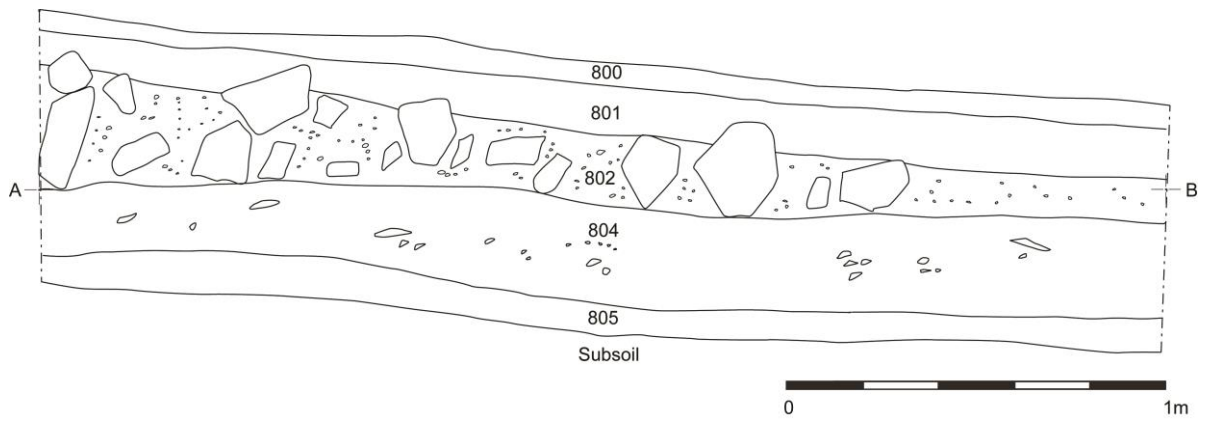

Figure 28: East facing section of Trench 8



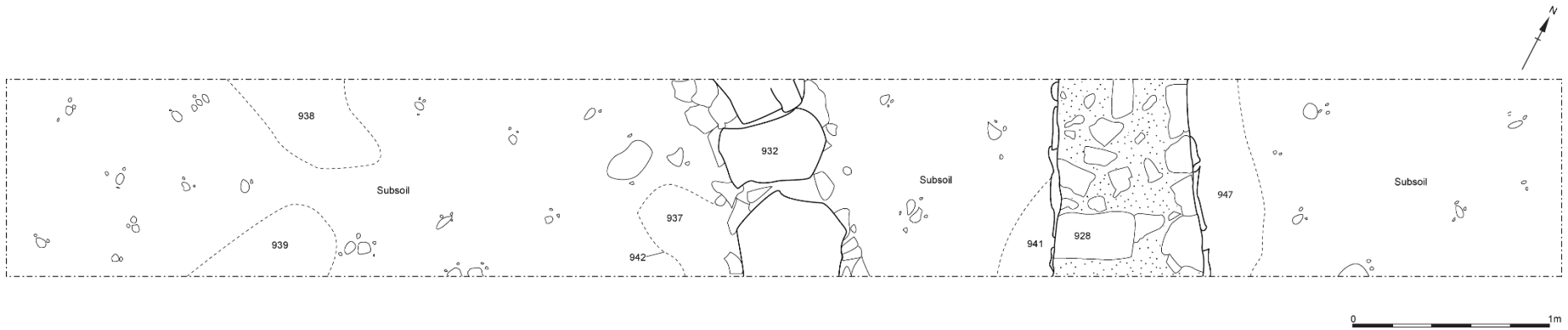

Figure 29: Post-excavation plan of Trench 9a

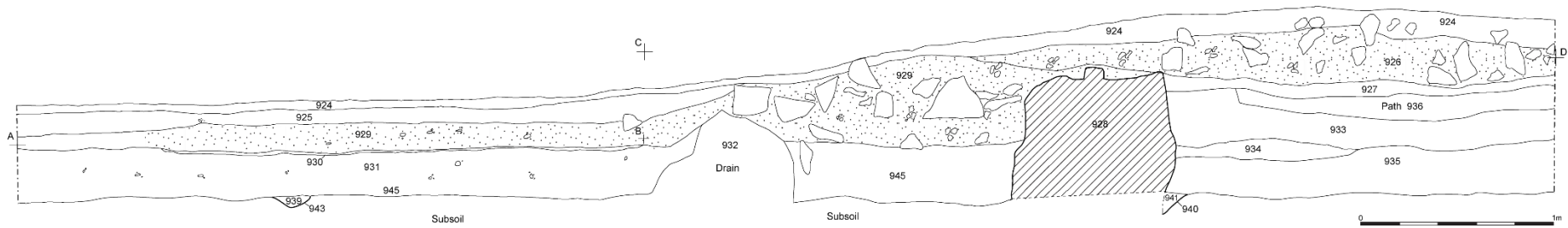

Figure 30: South facing section of Trench 9a

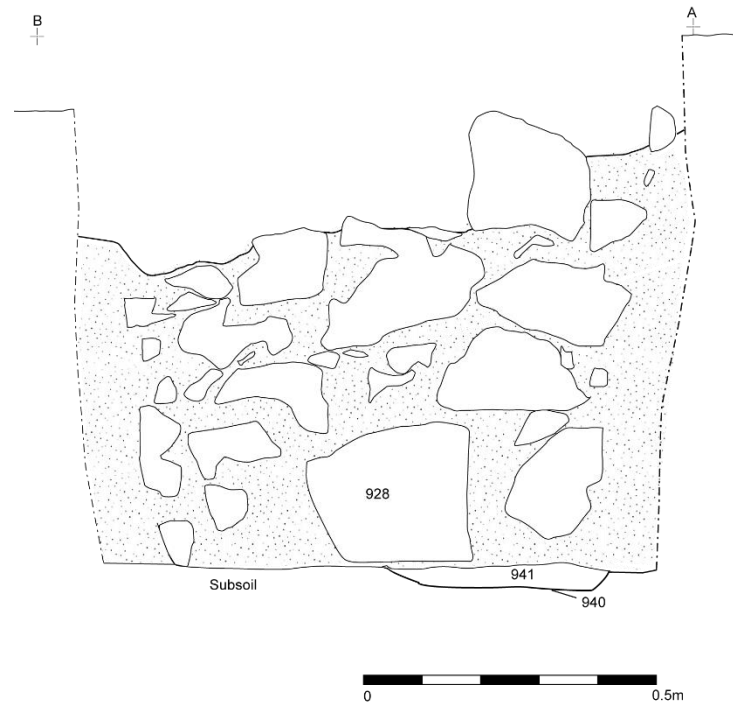

Figure 31: Trench 9a, west facing elevation of wall 928

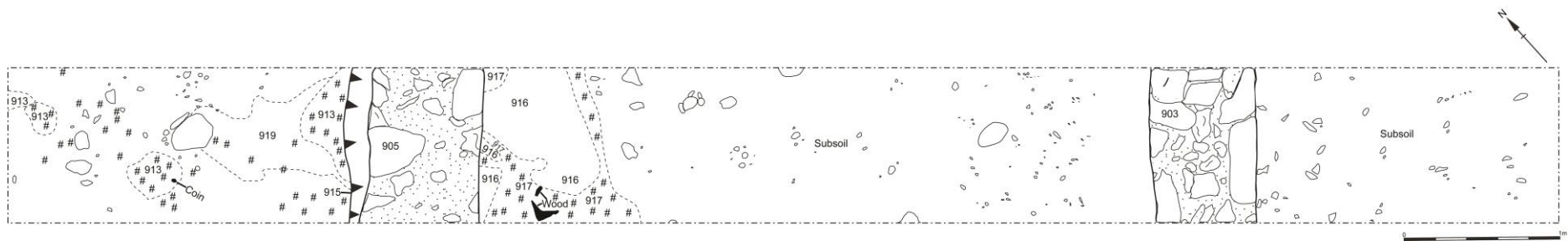

Figure 32: Trench 9b, mid-excavation plan showing burnt deposits 913, 916, 917

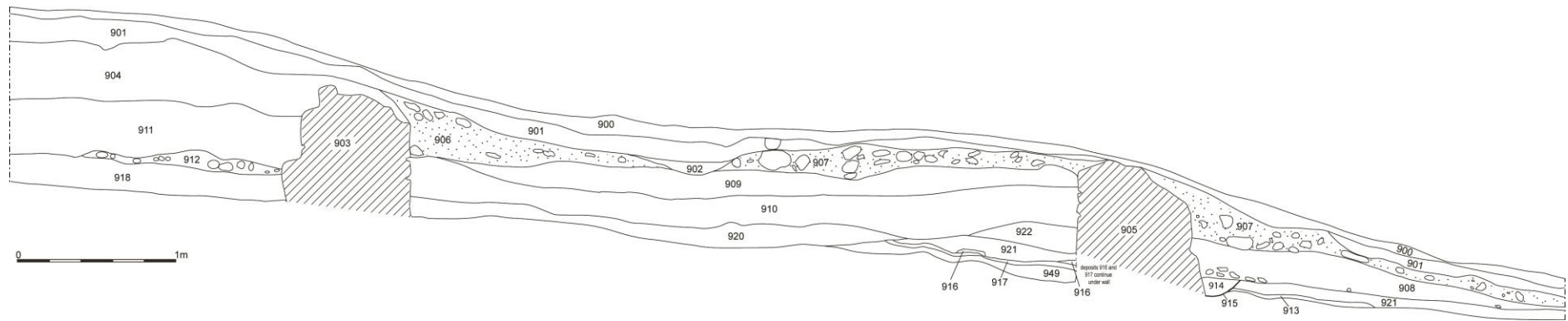

Figure 33: East facing section of Trench 9b

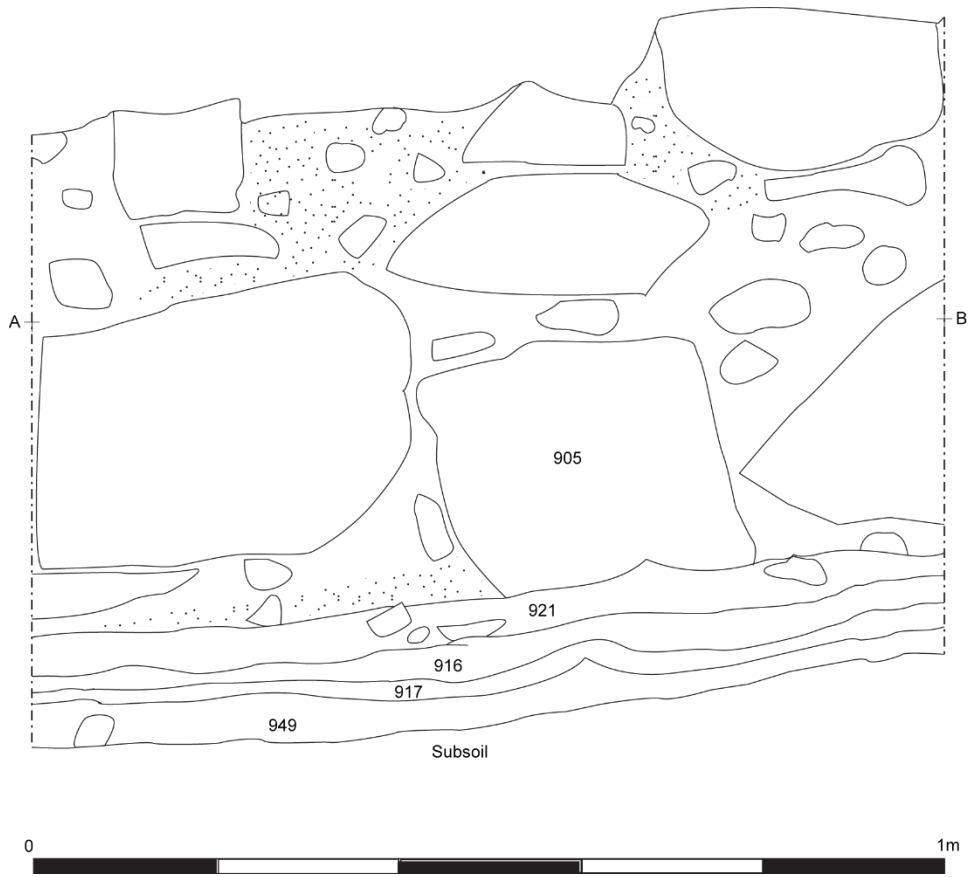

Figure 34: Trench 9b, south facing elevation of wall 905

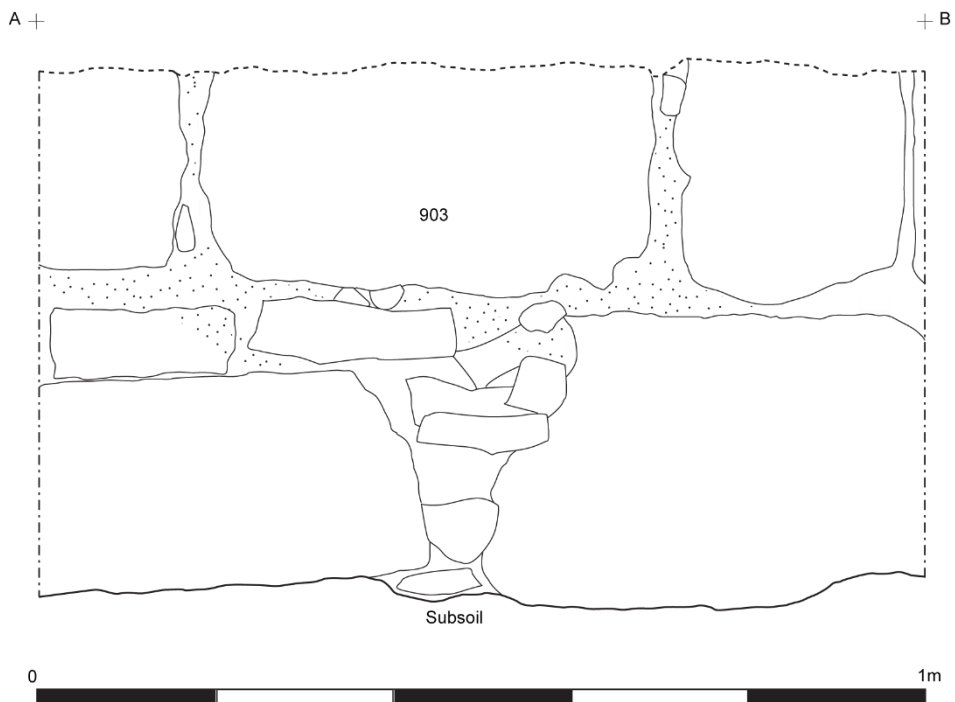

Figure 35: Trench 9b, south facing elevation of wall 903



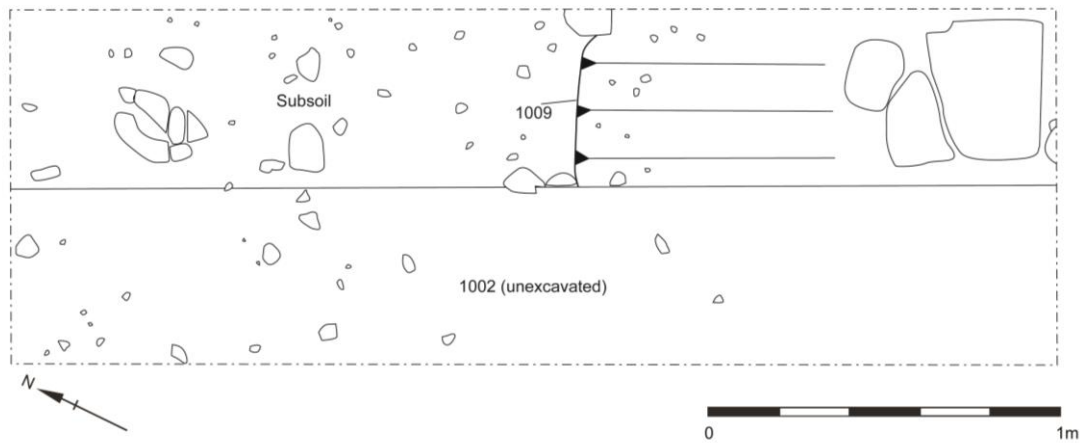

Figure 36: Post-excavation plan of Trench 10

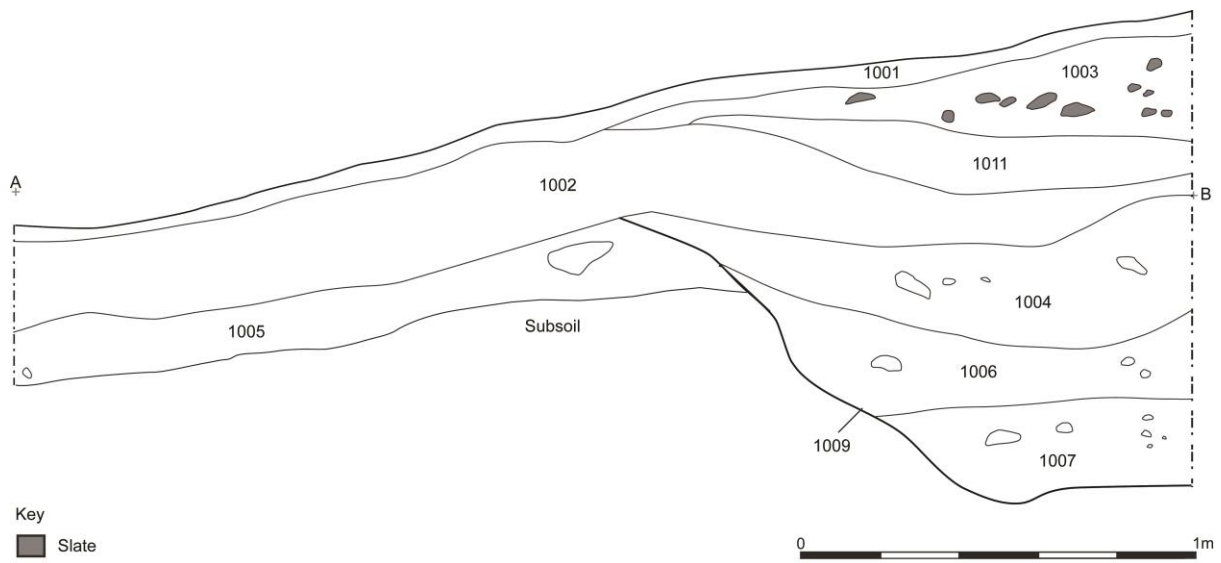

Figure 37: West facing section of Trench 10

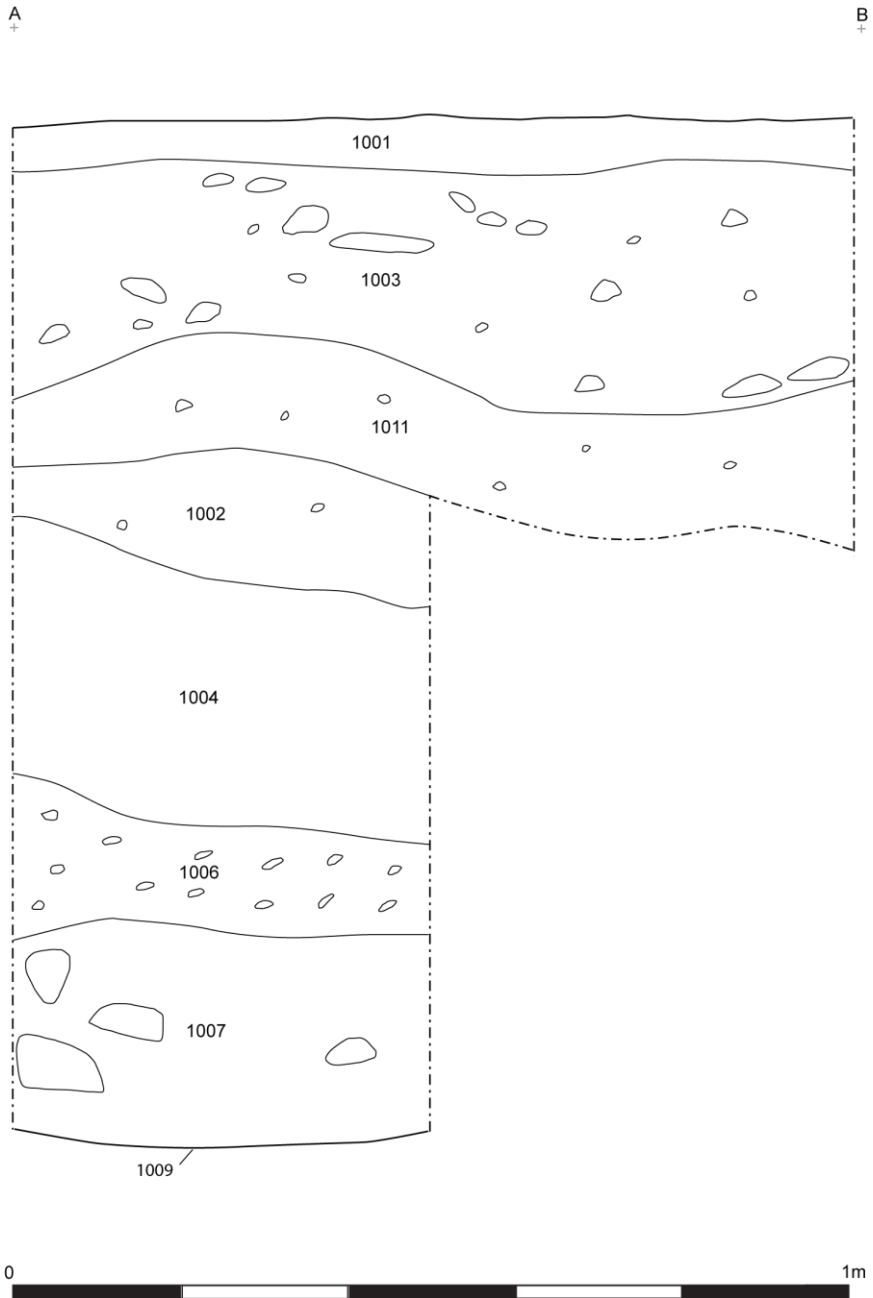

Figure 38: North facing section of Trench 10

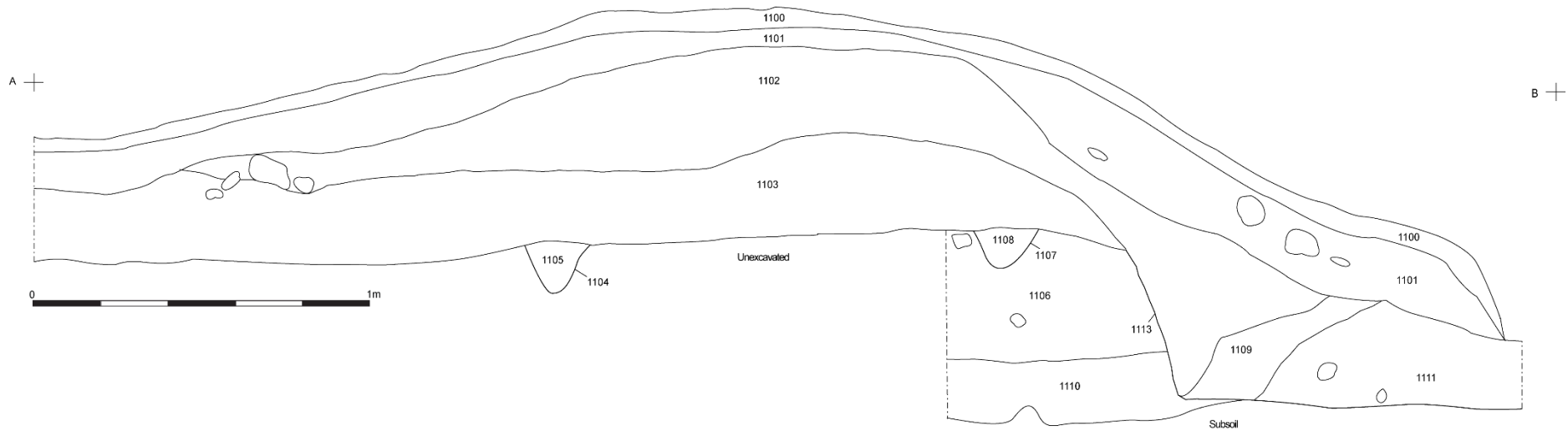

Figure 39: North facing section of Trench 11

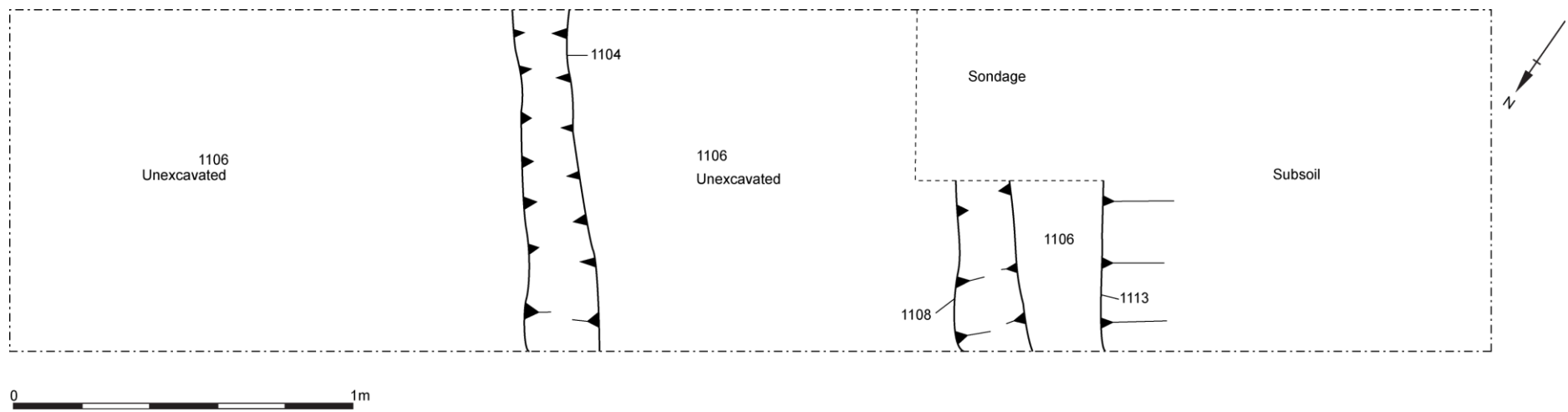

Figure 40: Post-excavation plan of Trench 11

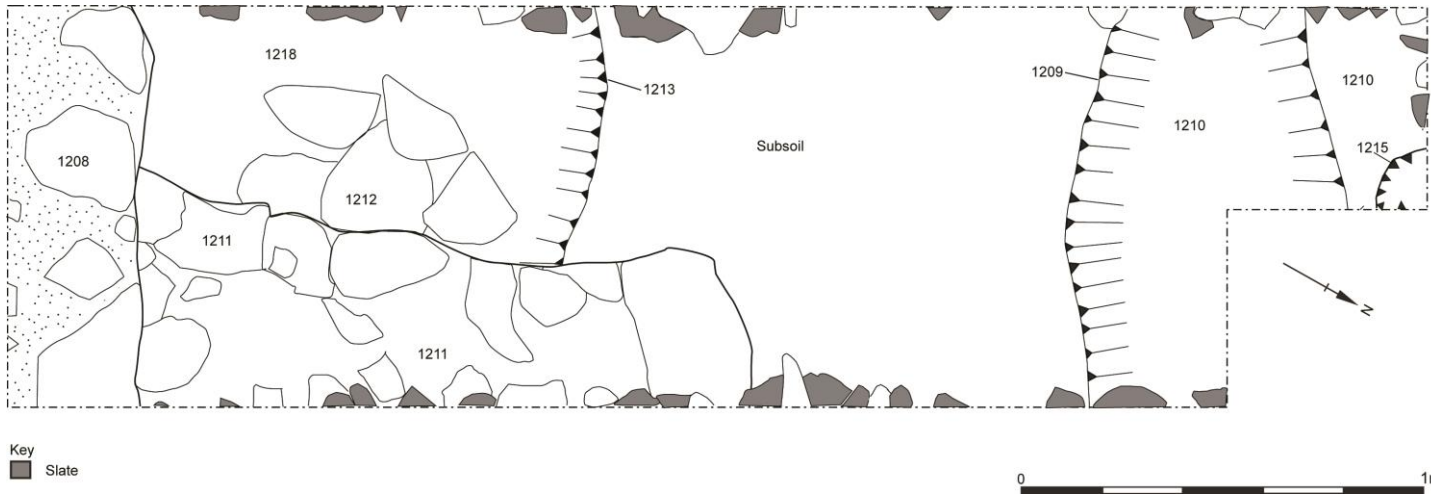

Figure 41: Post-excavation plan of Trench 12

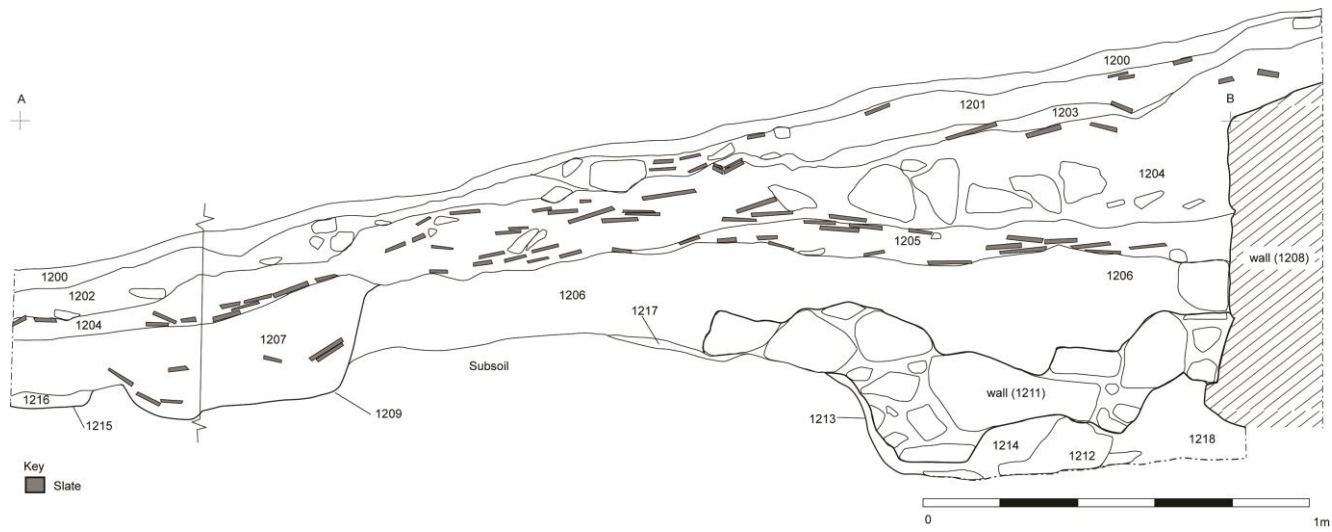

Figure 42: West facing section of Trench 12



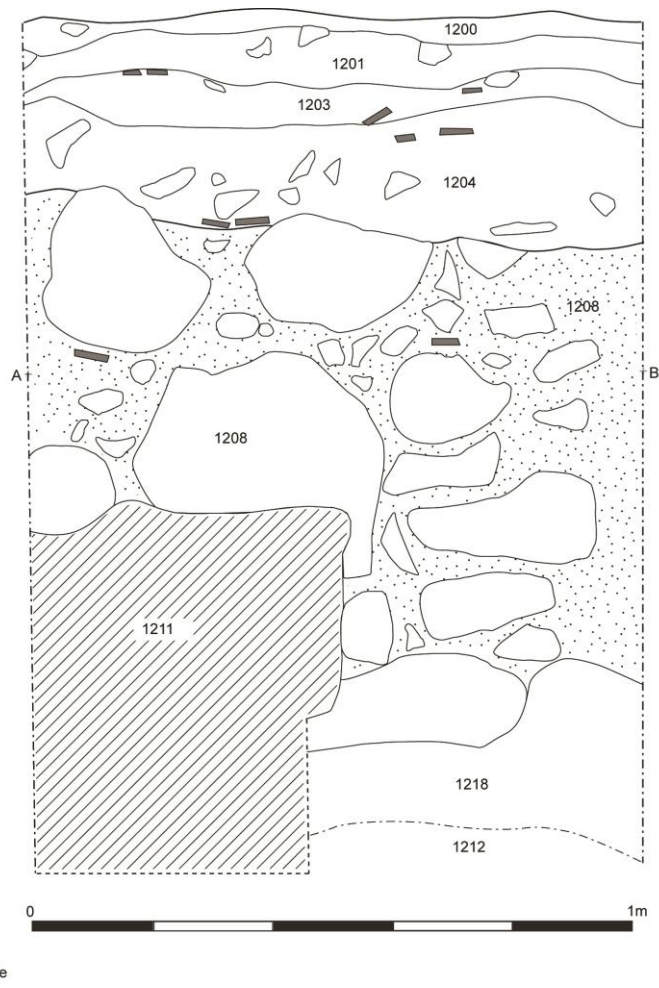

Figure 43: Trench 12, north facing elevation of walls 1208 and 1211

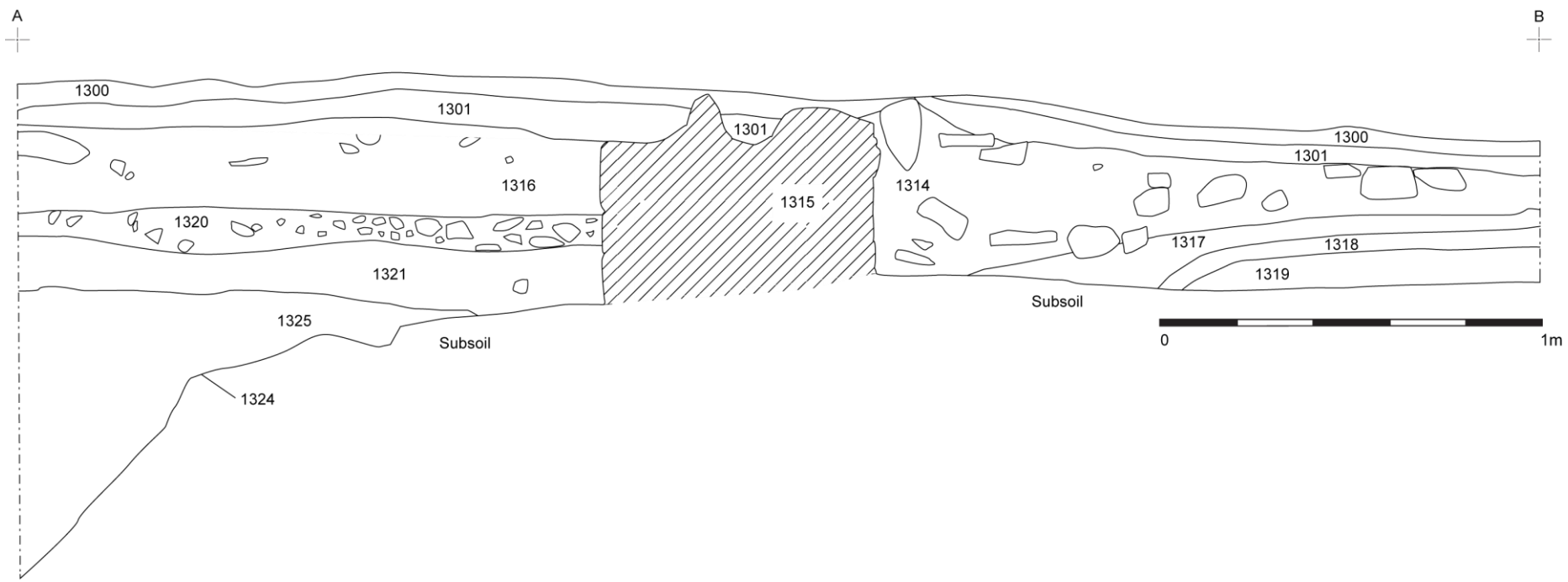

Figure 44: North facing section of Trench 13a

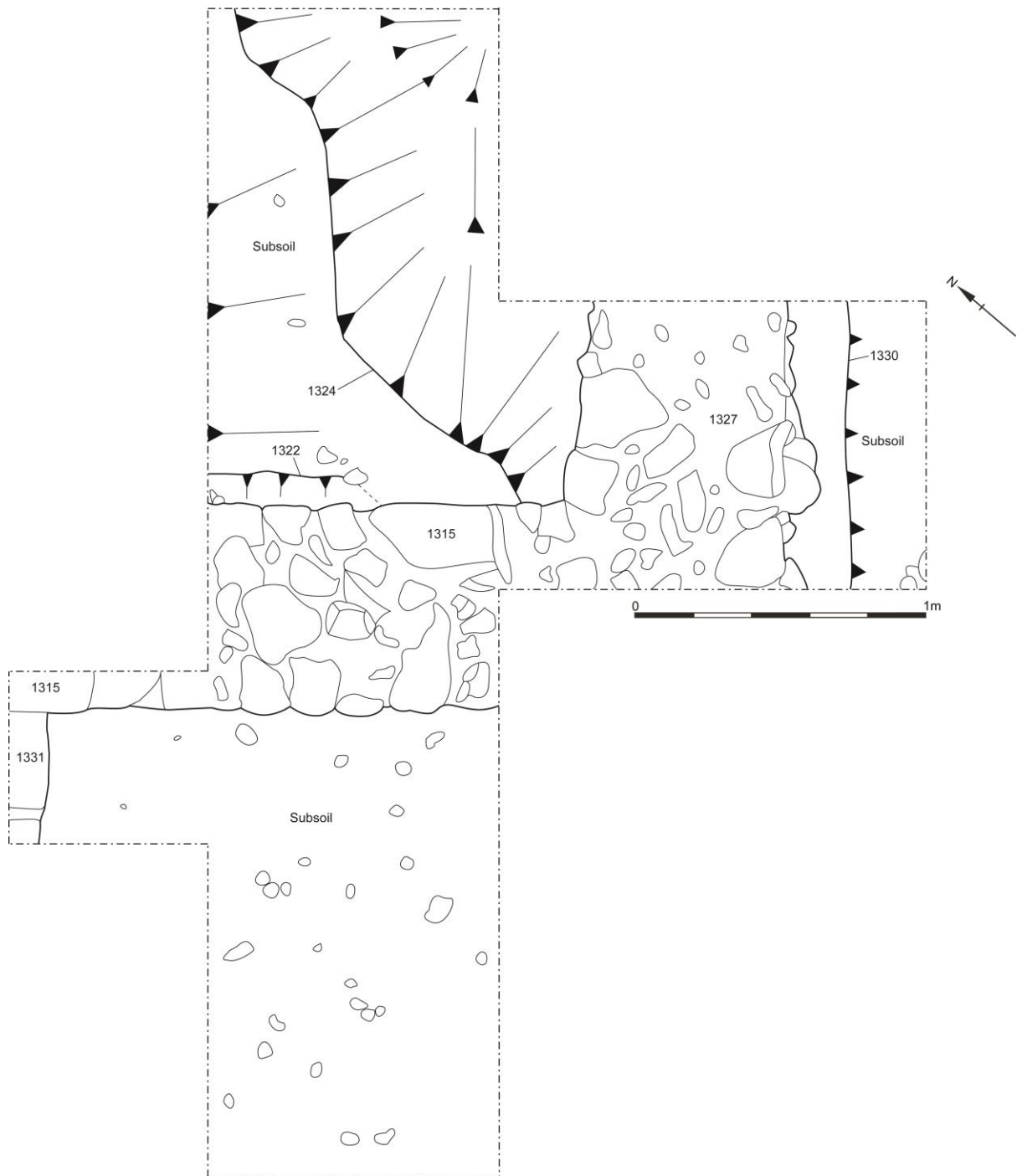

Figure 45: Post-excavation plan of Trench 13a

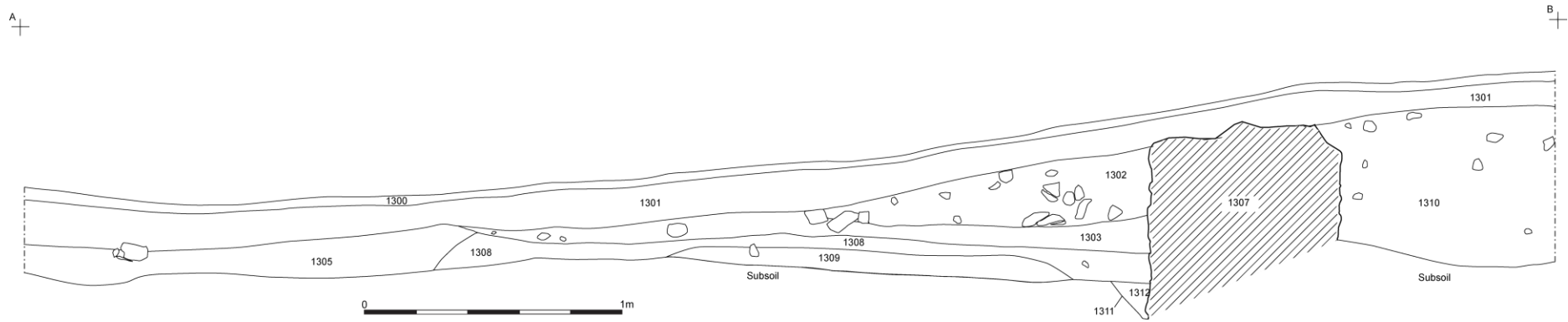

Figure 46: West facing section of Trench 13b

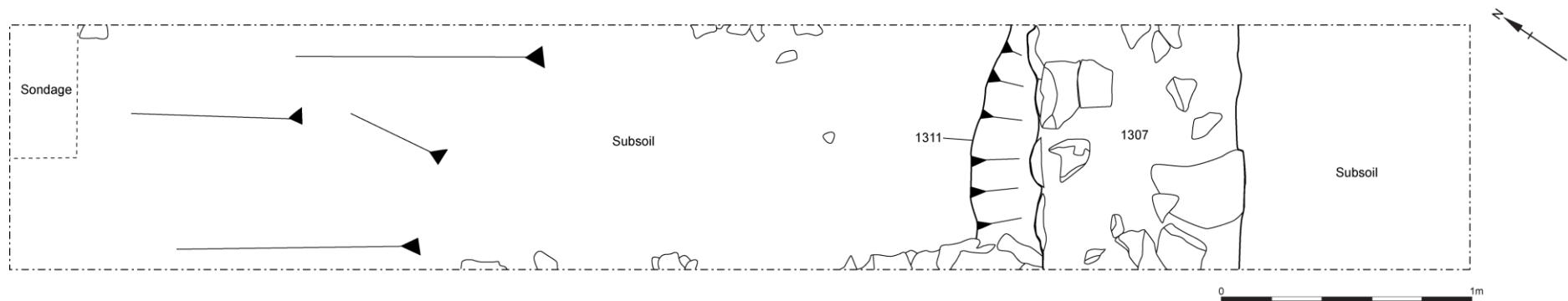

Figure 47: Post-excavation plan of Trench 13b

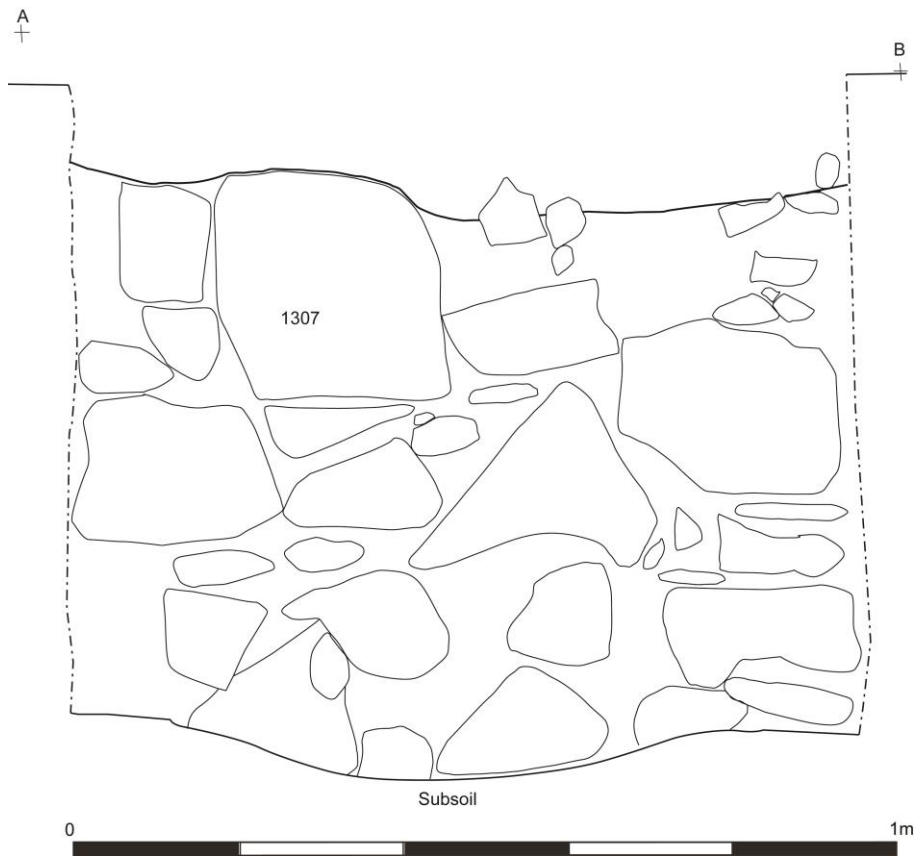

Figure 48: Trench 13b, north facing elevation of wall 1307

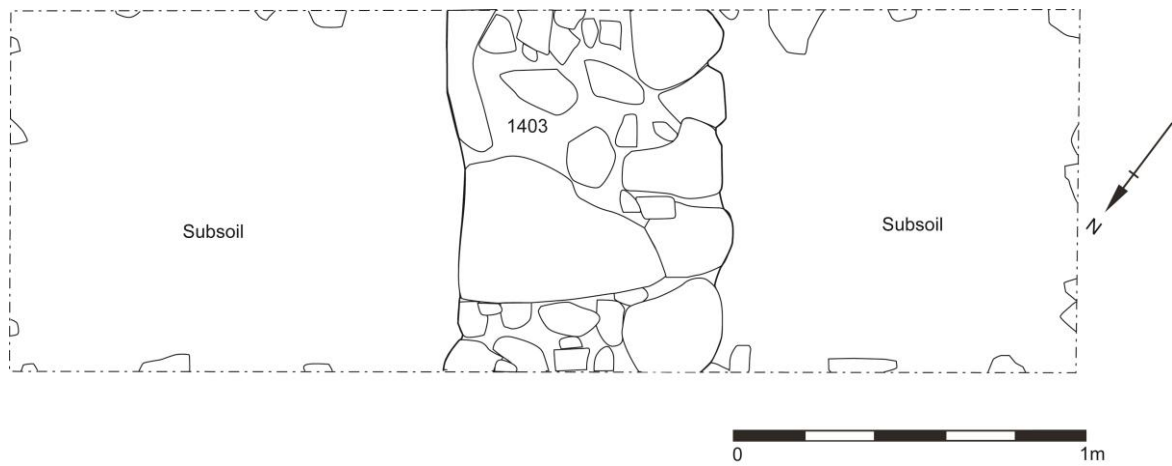

Figure 49: Post-excavation plan of Trench 14



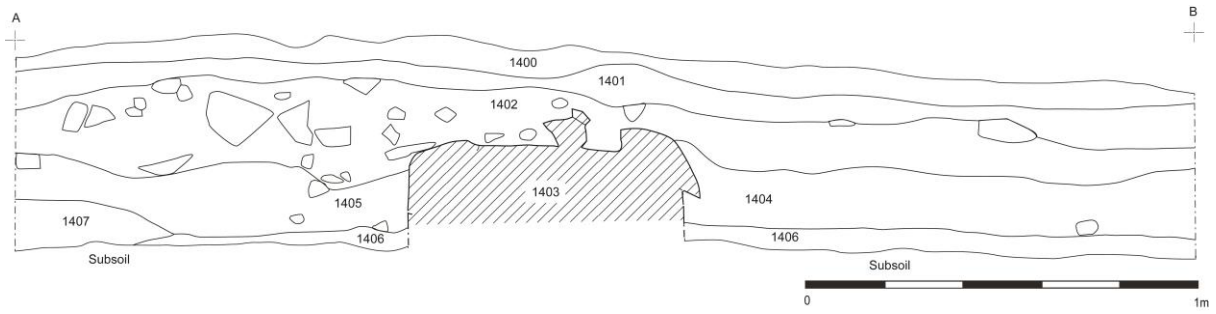

Figure 50: South facing elevation of Trench 14

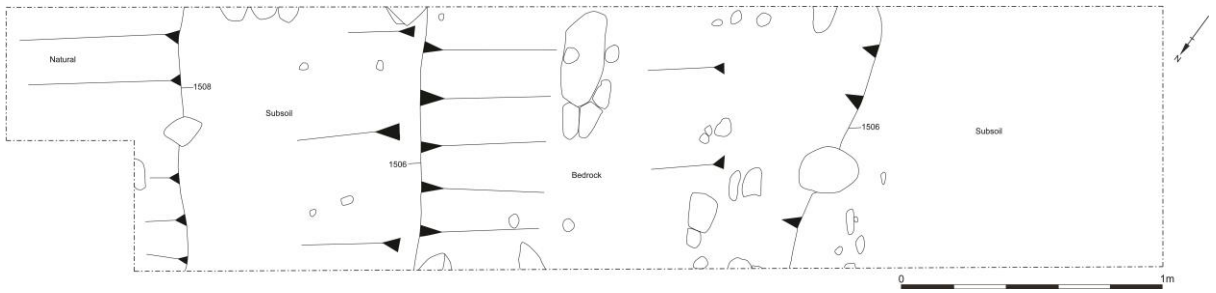

Figure 51: Post-excavation plan of Trench 15a

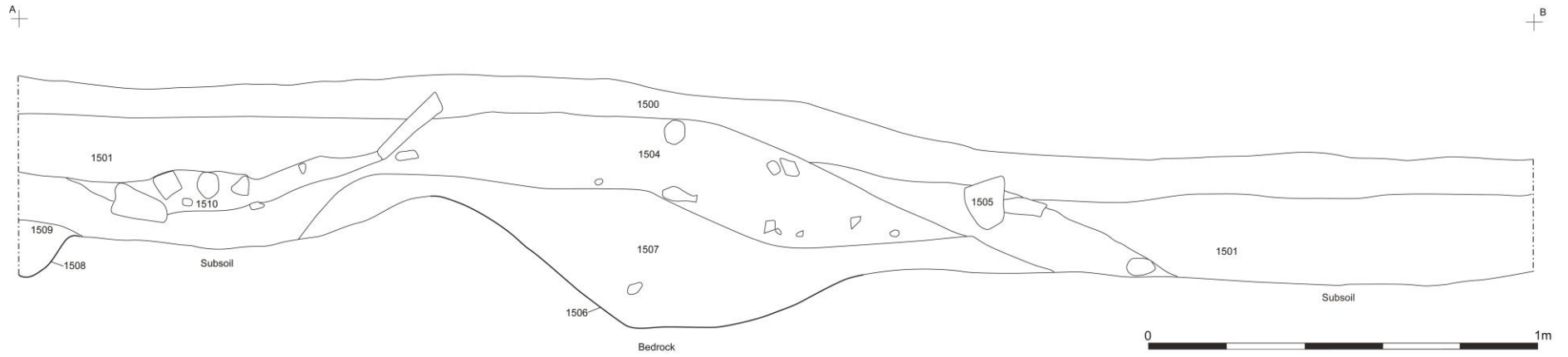

Figure 52: North facing section of Trench 15a

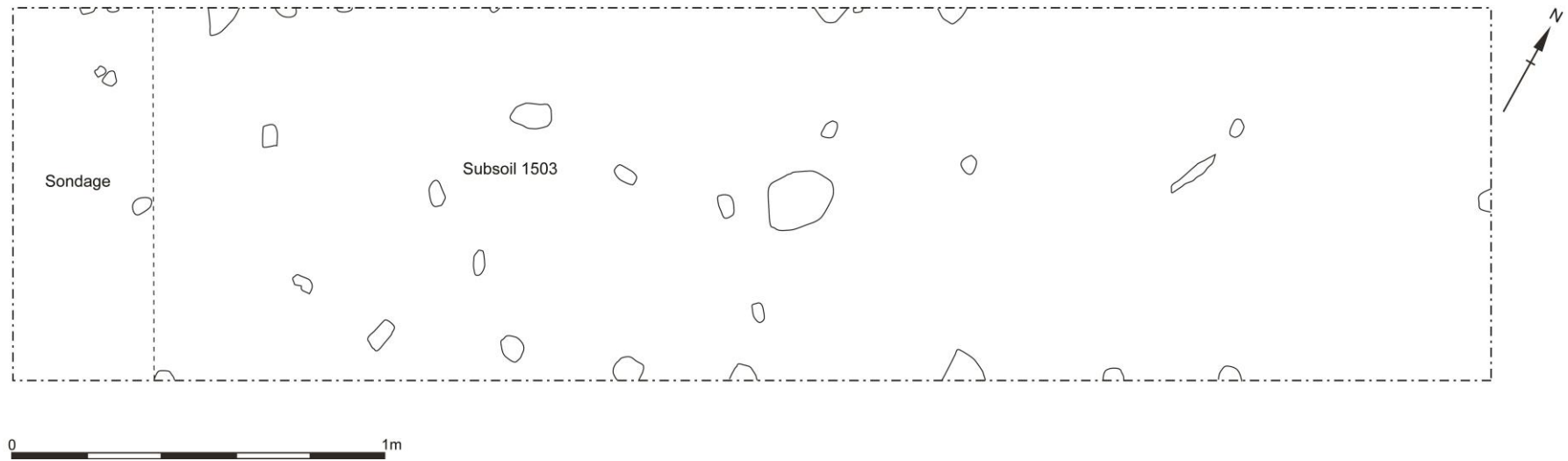

Figure 53: Post-excavation of Trench 15b

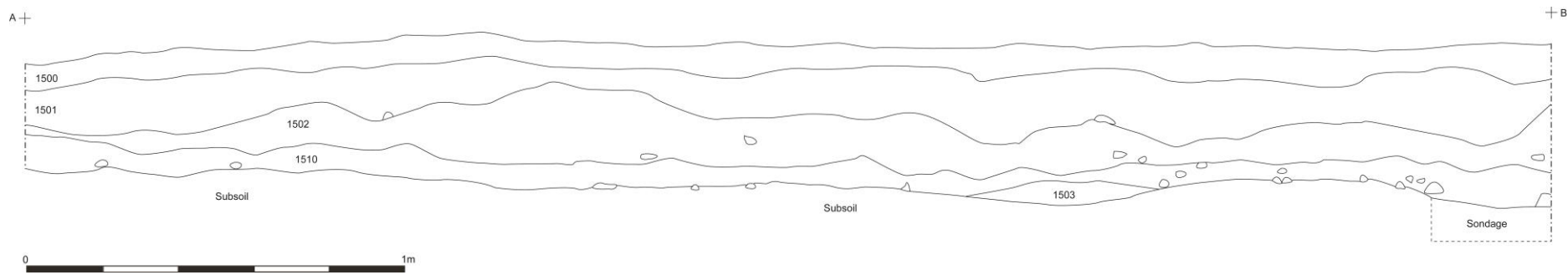

Figure 54: North facing section of Trench 15b

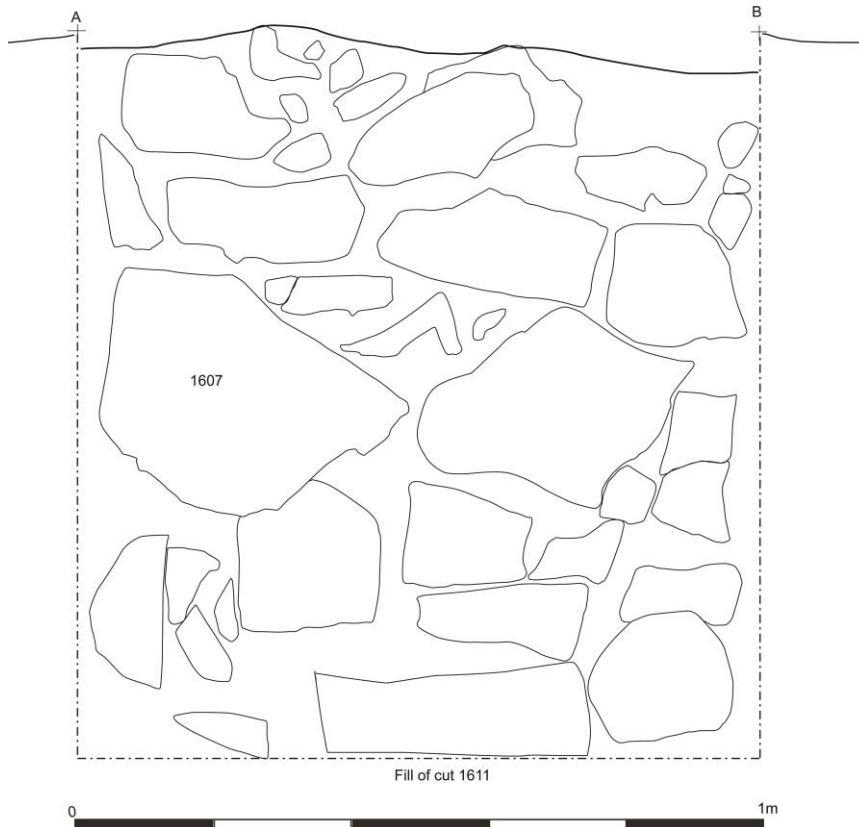

Figure 55: Trench 16, north facing elevation of wall 1607

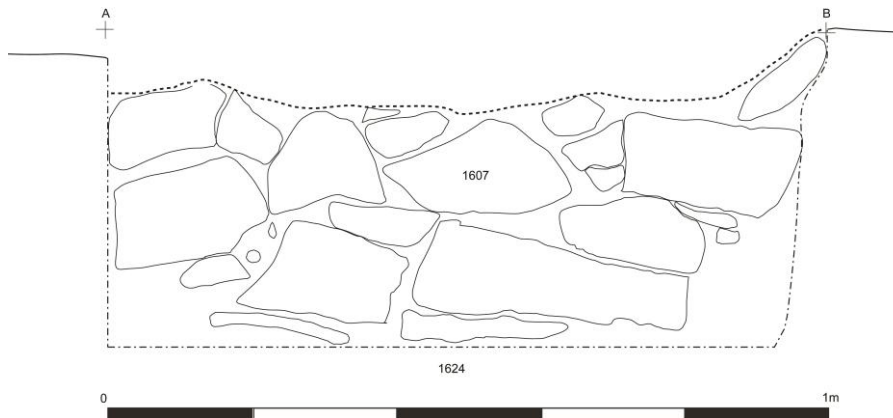

Figure 56: Trench 16, south facing elevation of wall 1607

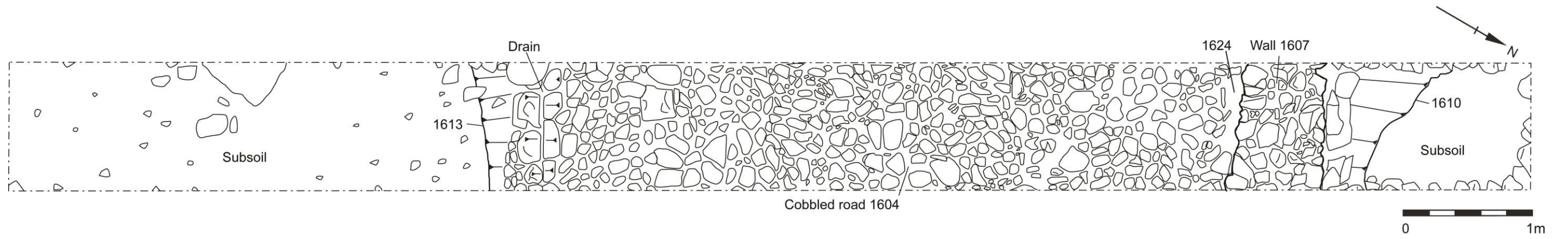

Figure 57: Post-excavation of Trench 16

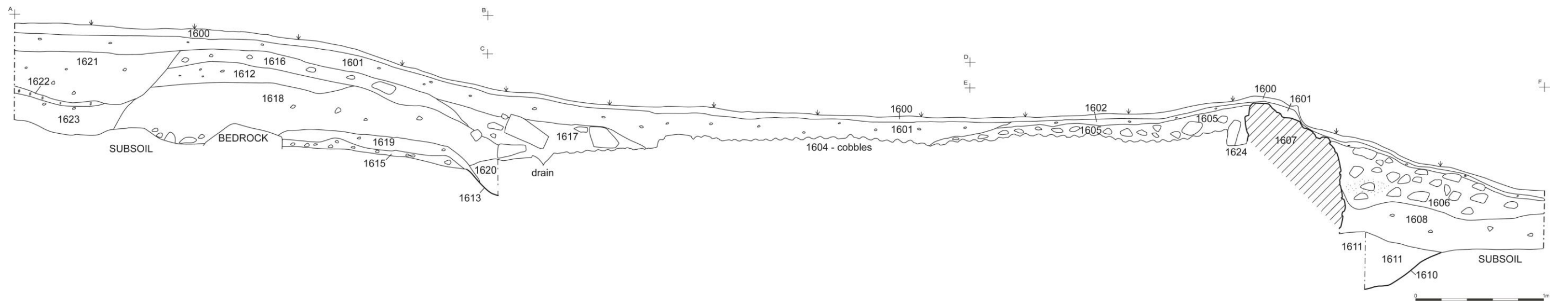

Figure 58: East facing section of Trench 16

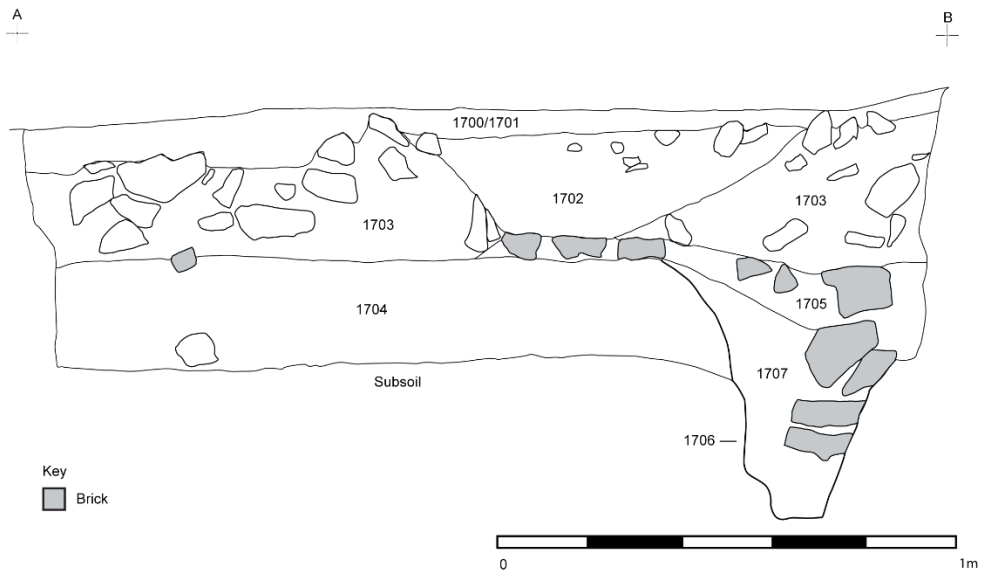

Figure 59: South facing section of Trench 17

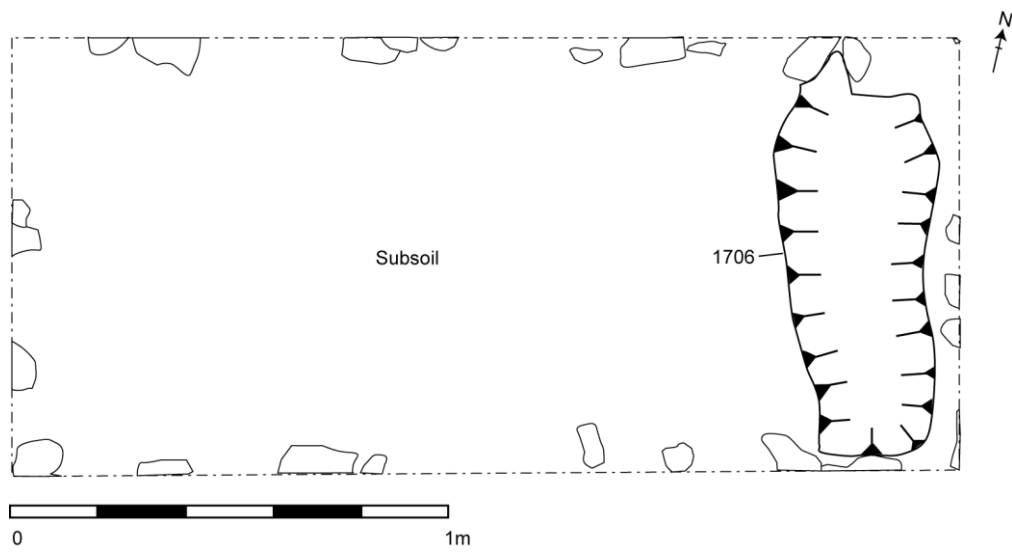

Figure 60: Post-excavation plan of Trench 17



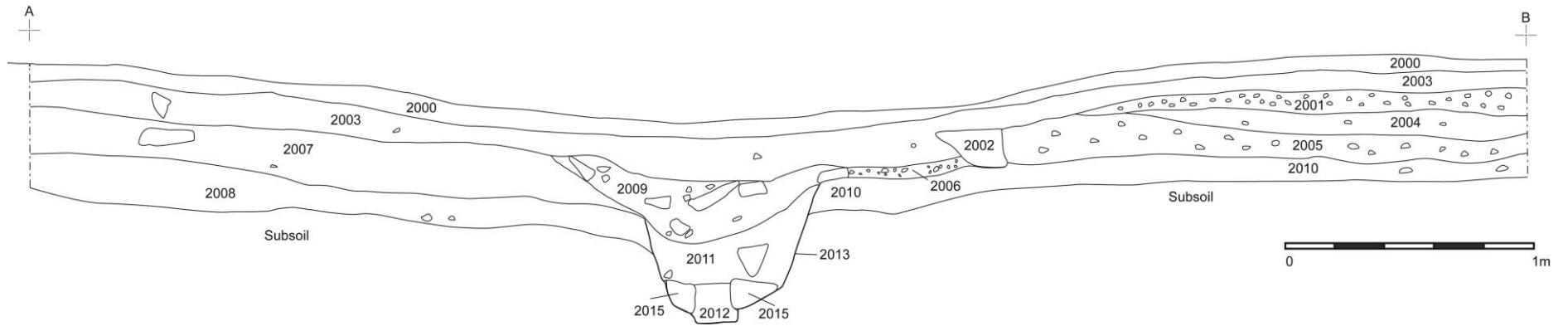

Figure 61: North facing section of Trench 20

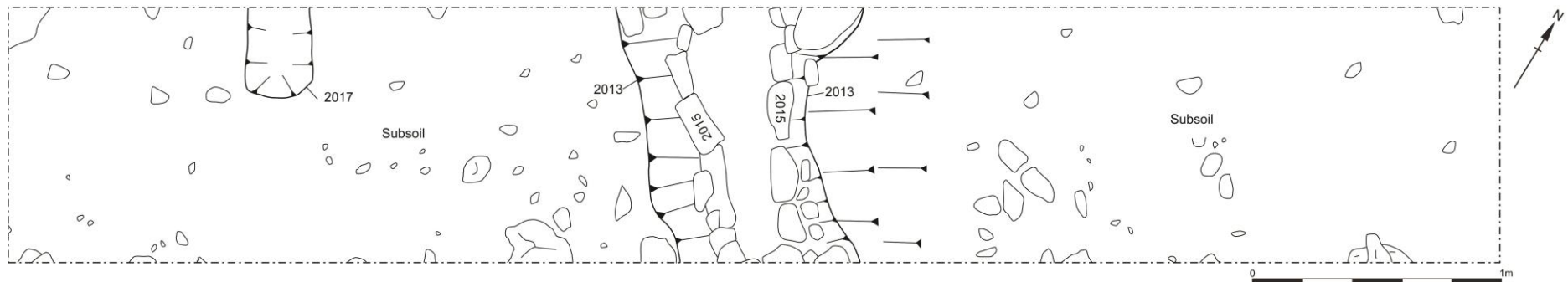

Figure 62: Post-excavation plan of Trench 20



Figure 63: Post-excavation of Trench 21

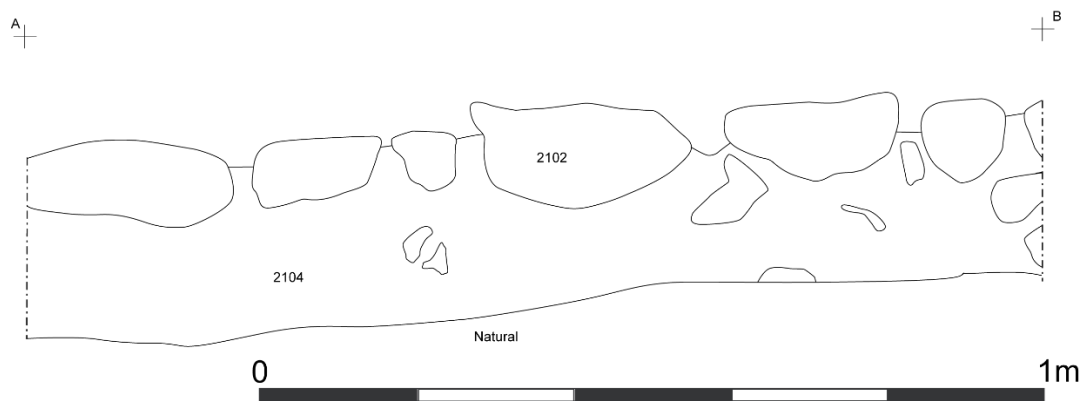

Figure 64: Trench 21 sondage, west facing section through cobbled surface 2102

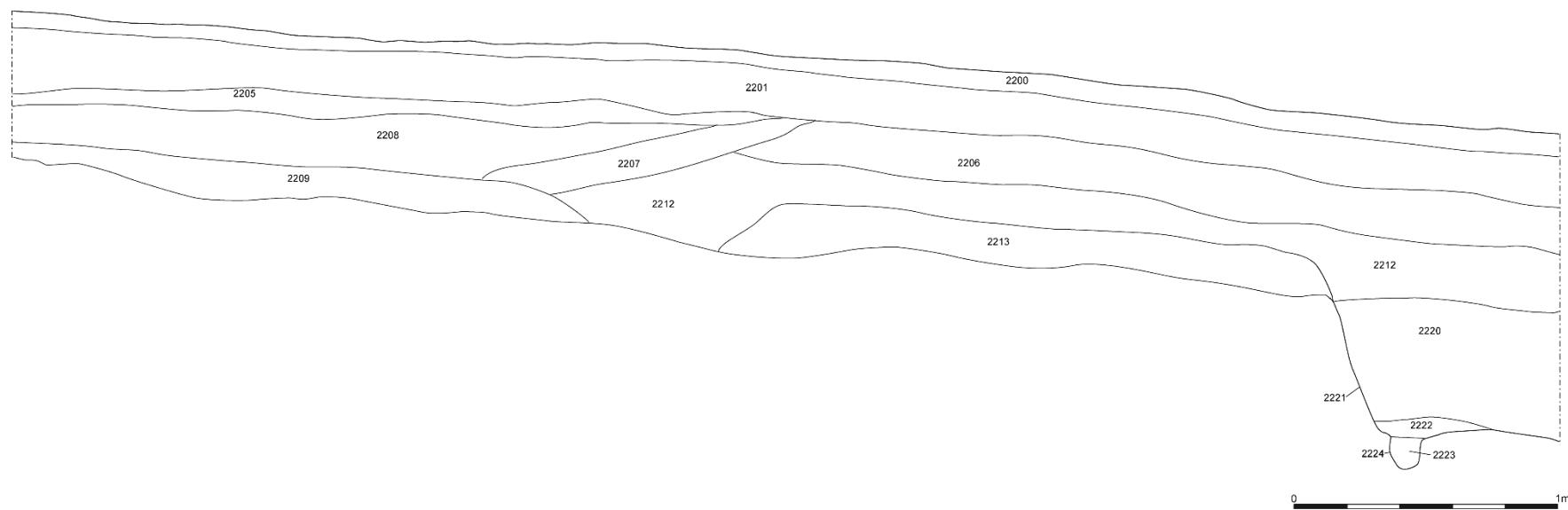

Figure 65: East facing section of Trench 22a

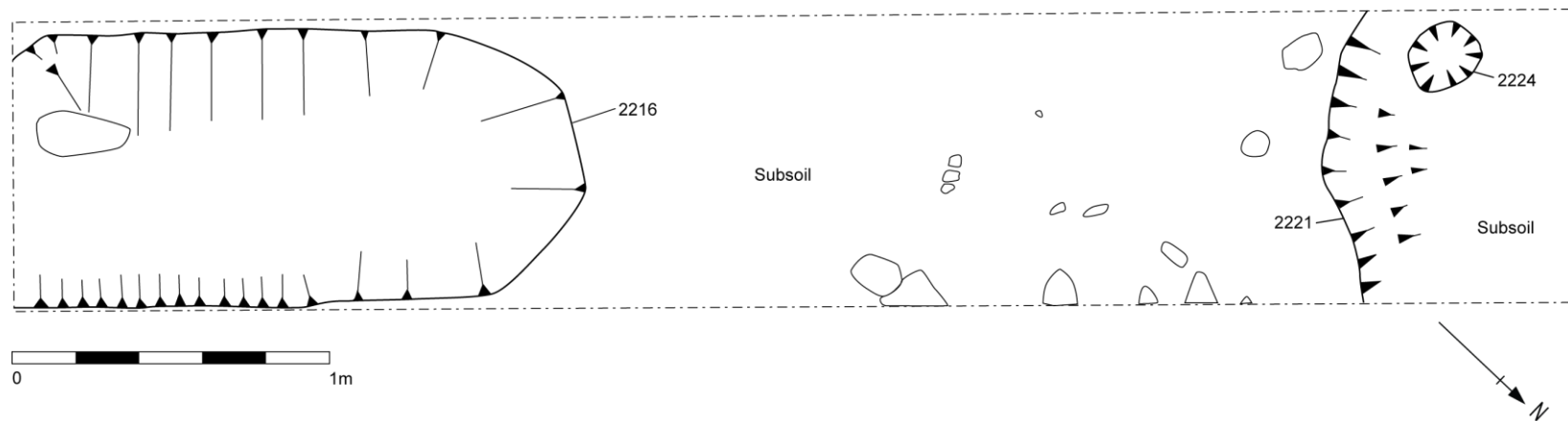

Figure 66: Post-excitation plan of Trench 22a

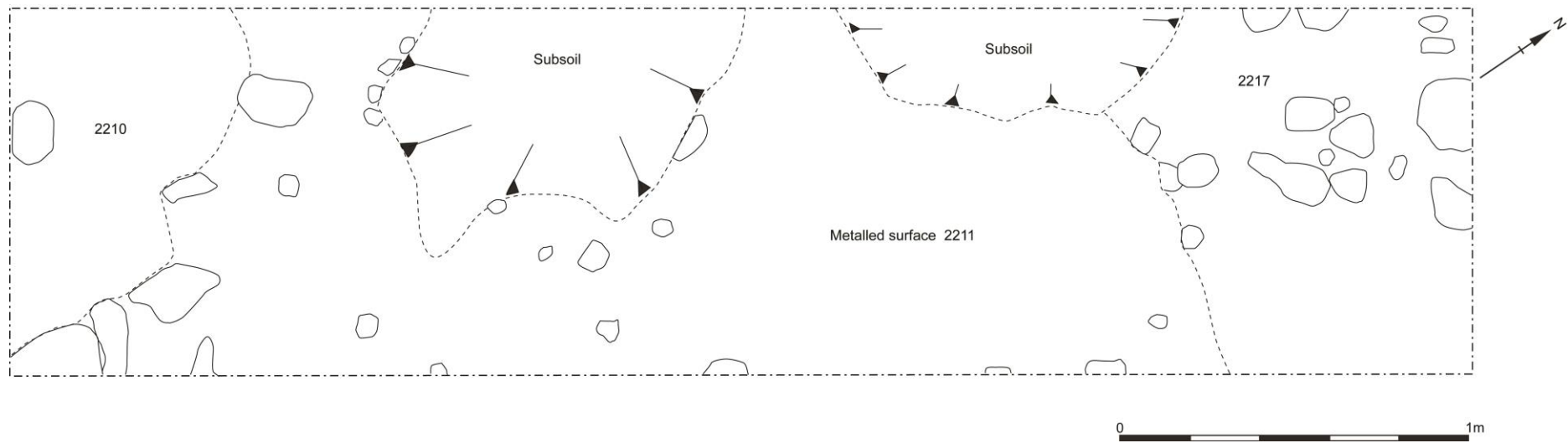

Figure 67: Post-excavation plan of Trench 22b

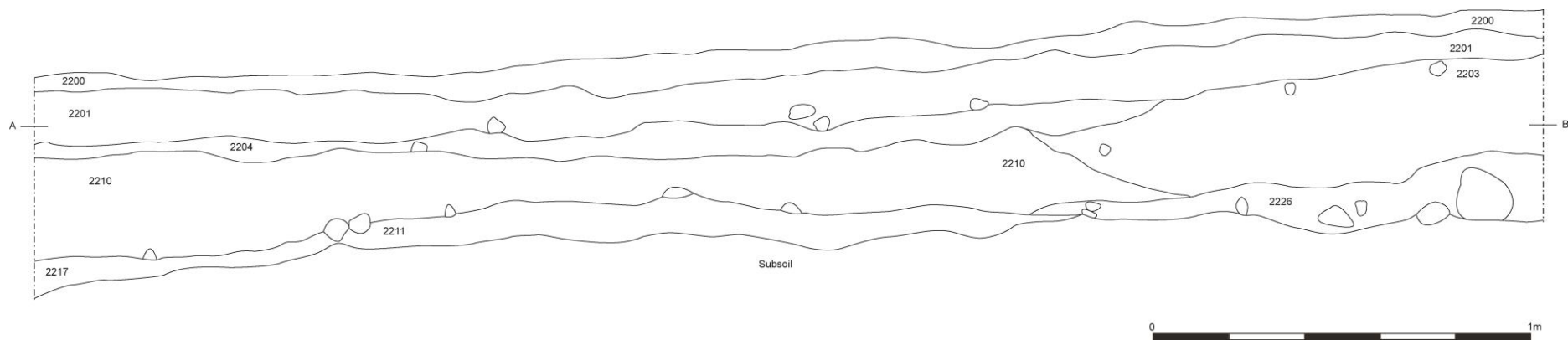

Figure 68: North facing section of Trench 22b

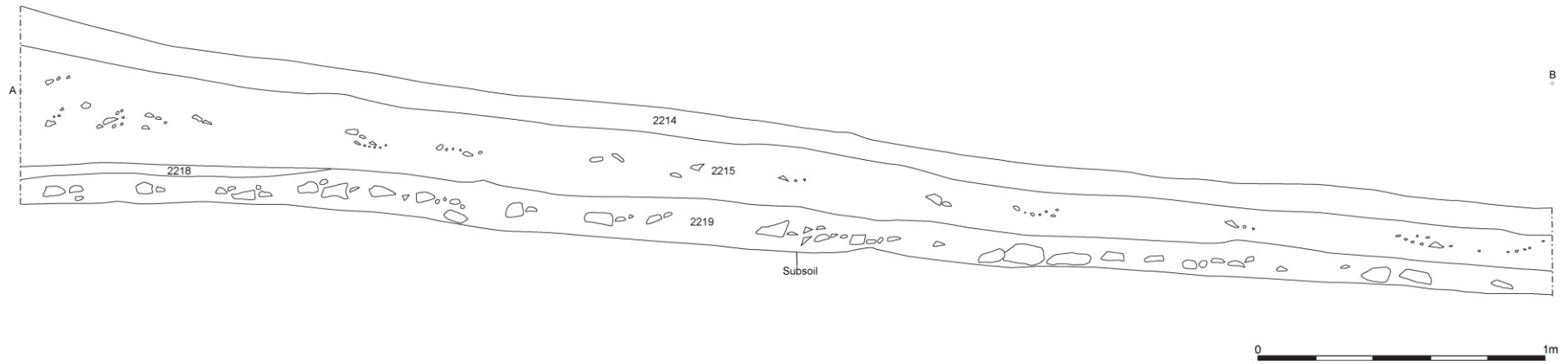

Figure 69: East facing section of Trench 22c

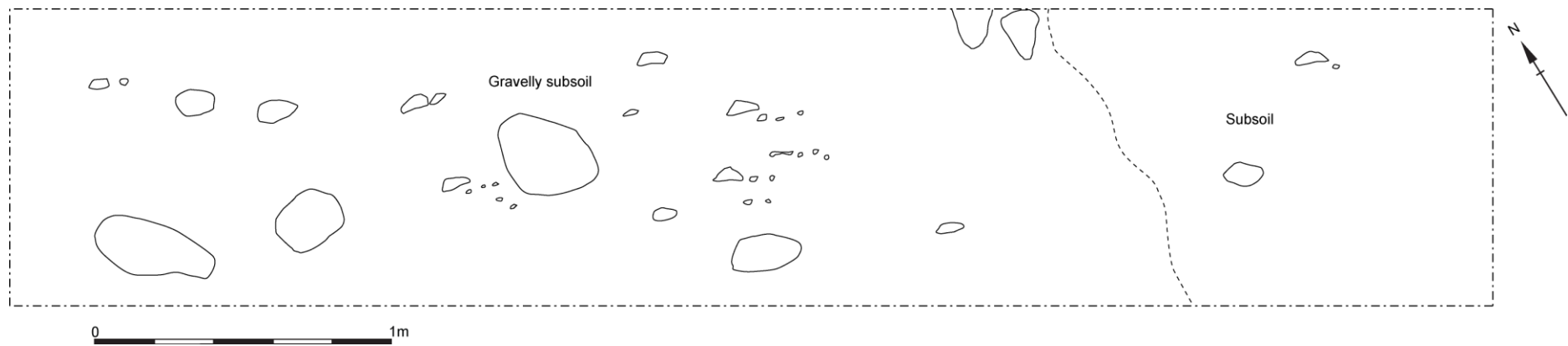

Figure 70: Post-excavation plan of Trench 22c

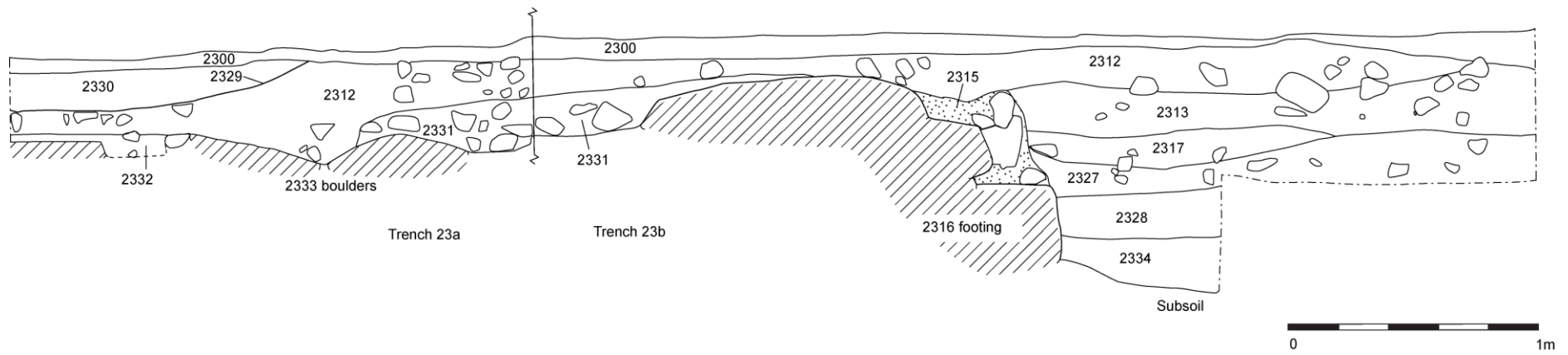

Figure 71: Continuous section through Trenches 23a and 23b

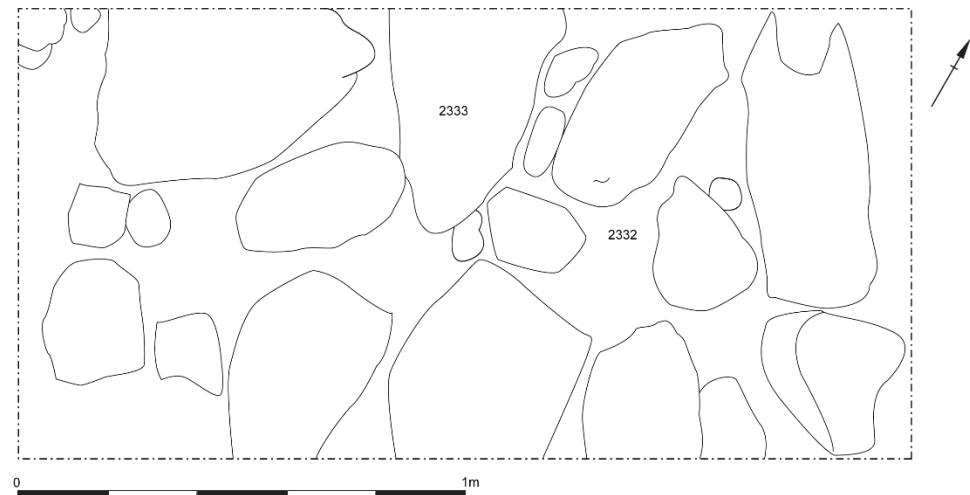

Figure 72: Post-excavation plan of Trench 23a



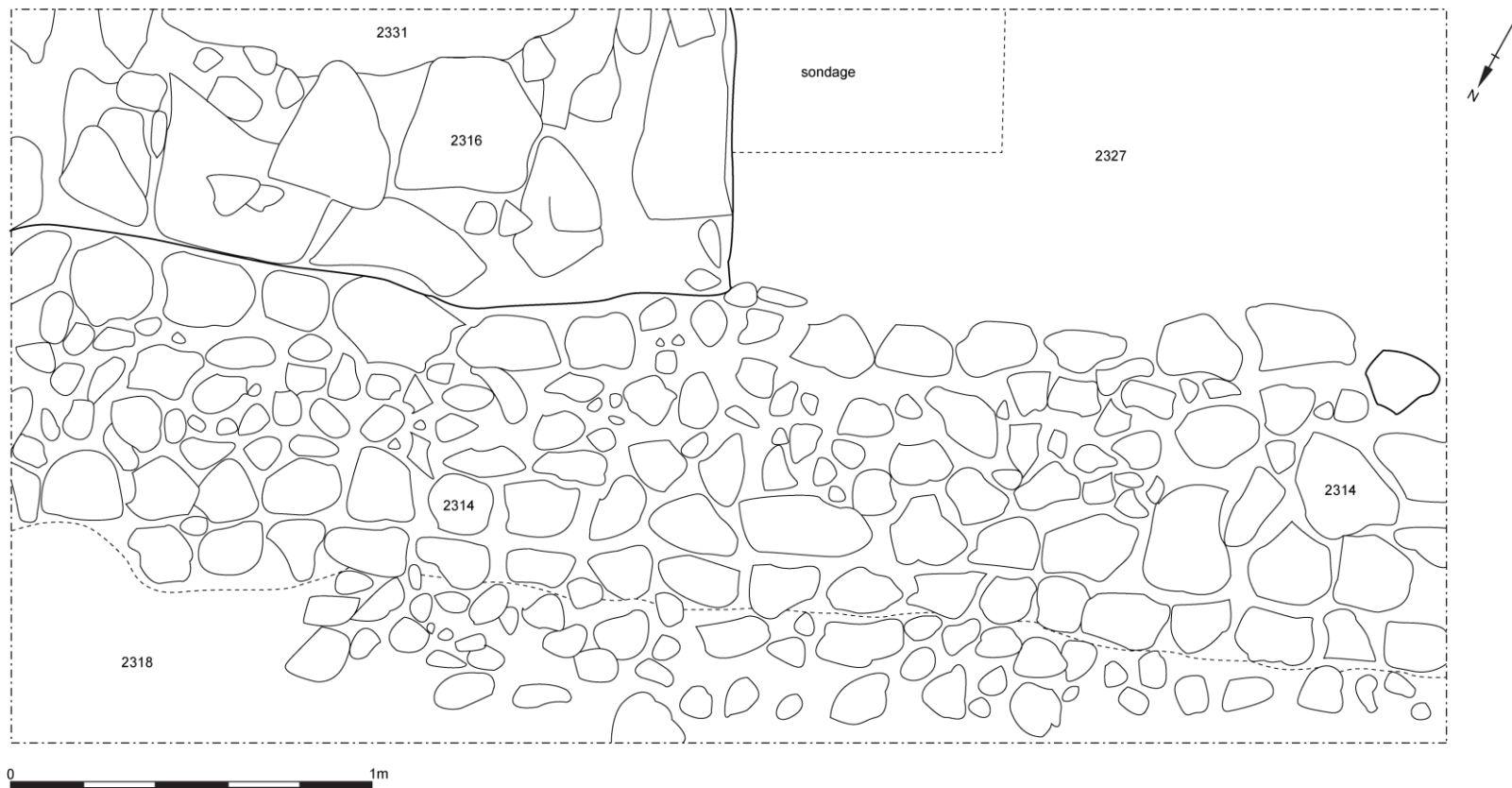

Figure 73: Post-excitation plan of Trench 23b

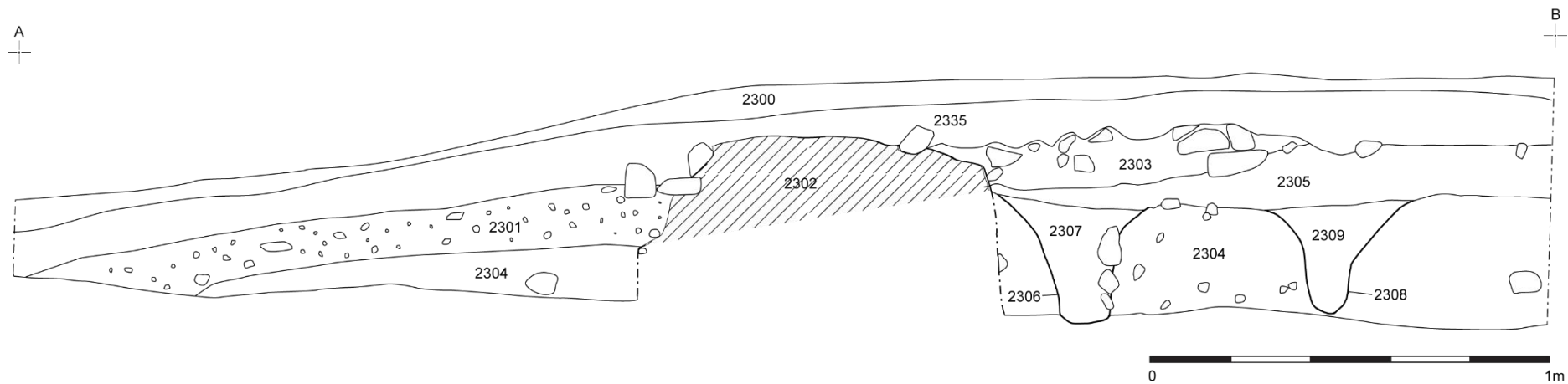

Figure 74: North facing section of Trench 23c

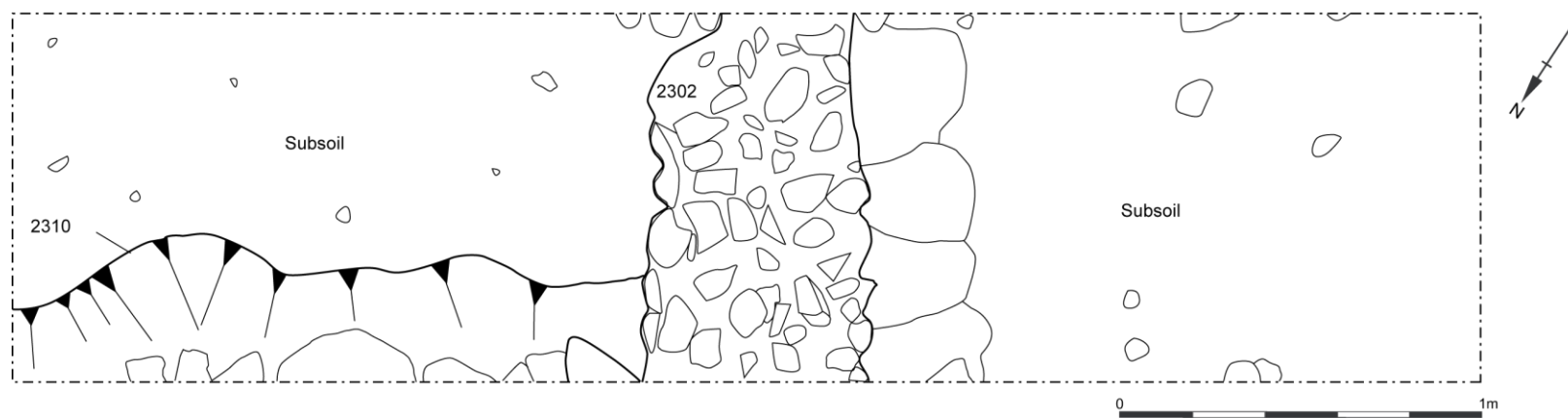

Figure 75: Post-excavation plan of Trench 23c

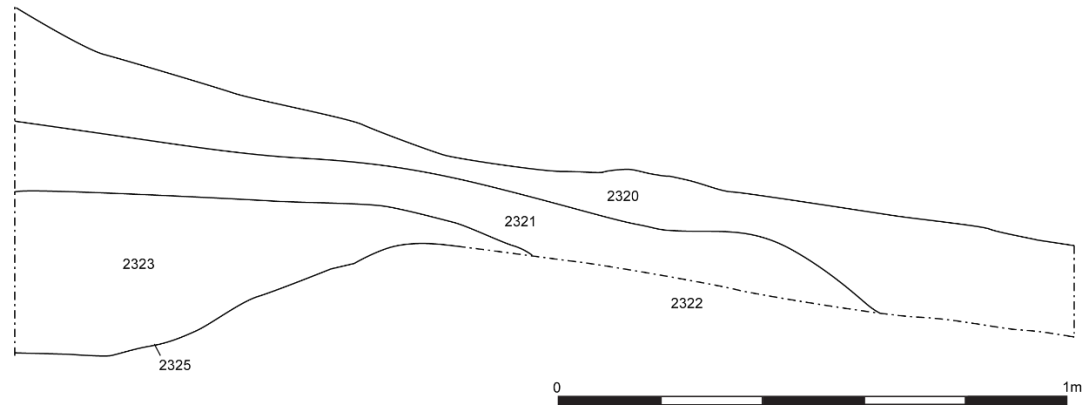

Figure 76: East facing section of Trench 23d

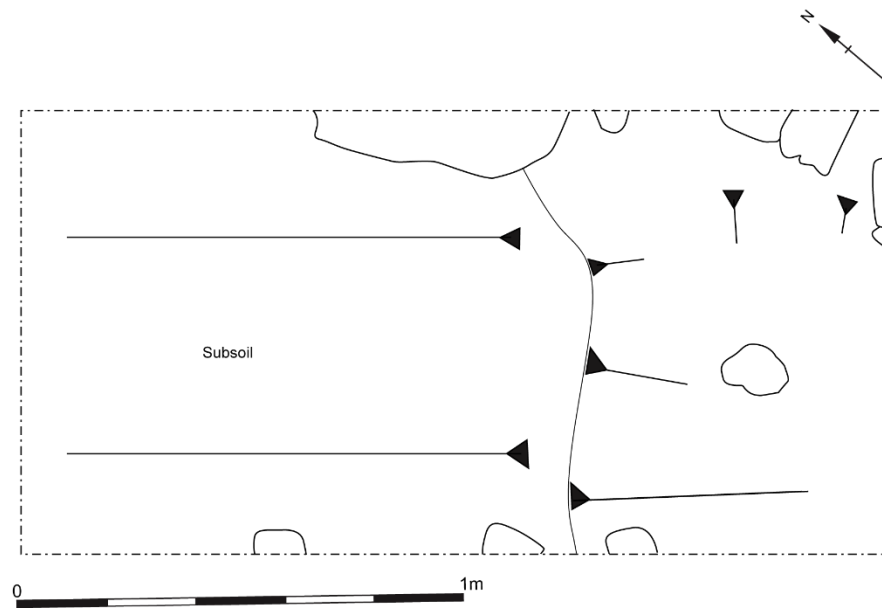

Figure 77: Post-excavation plan of Trench 23d

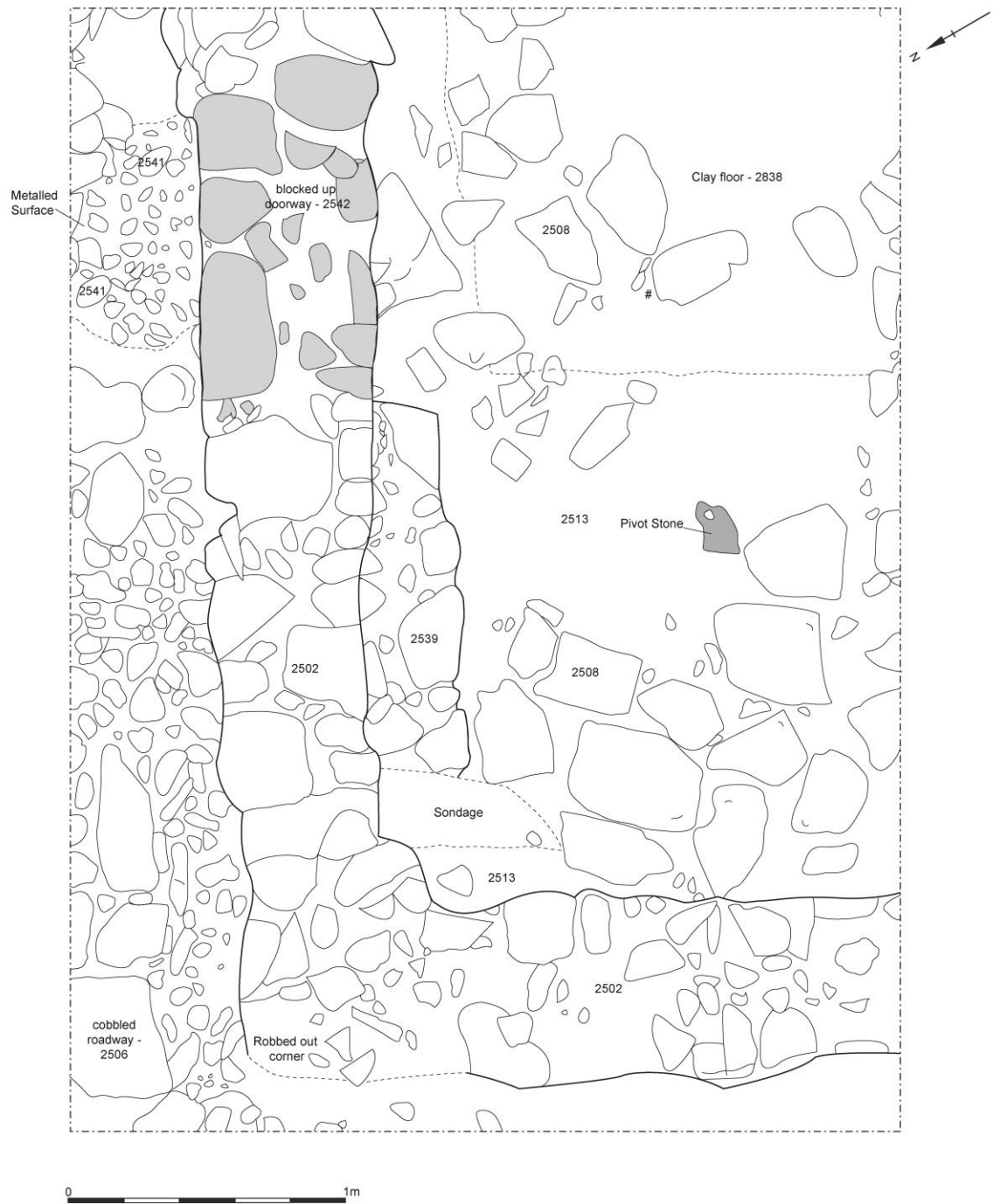

Figure 78: Post-excitation plan of Trench 25a

A +

+ B

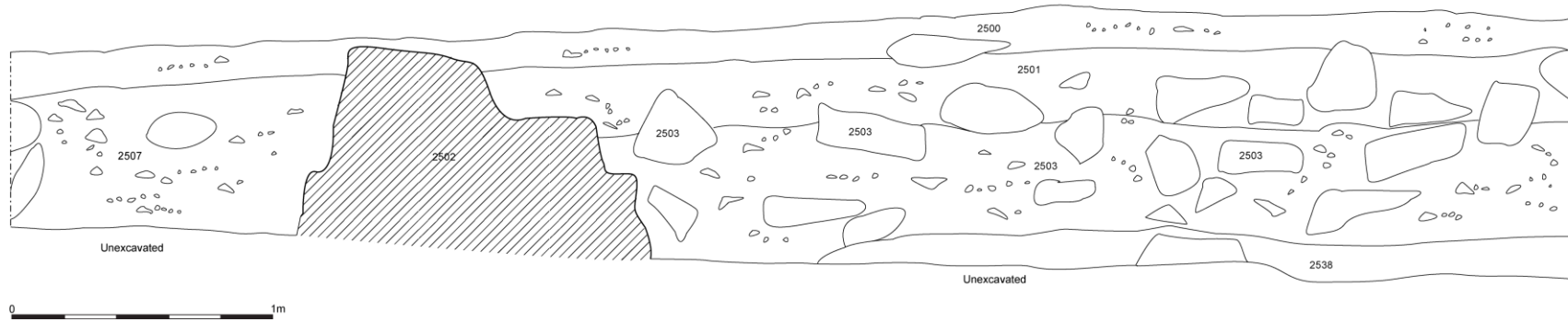

Figure 79: North facing section of Trench 25a

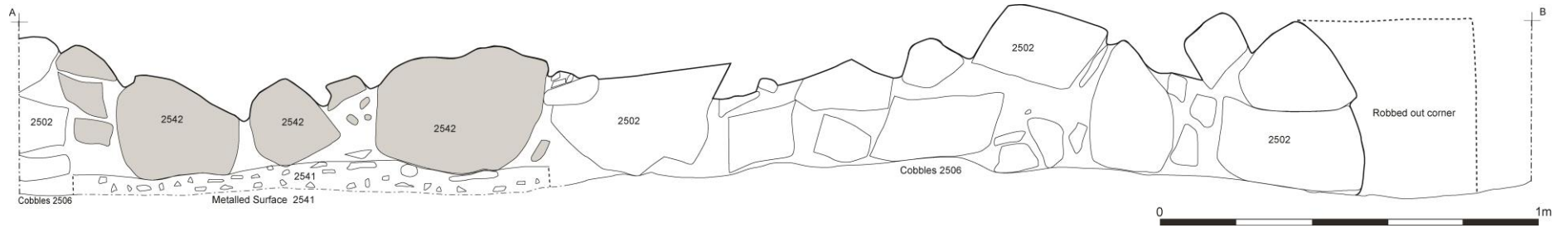

Figure 80: Trench 25a, east facing elevation of wall 2502 and possible blocked-up doorway 2542



Figure 81: Trench 25a, west facing elevation of wall 2502 and blocked-up doorway 2542



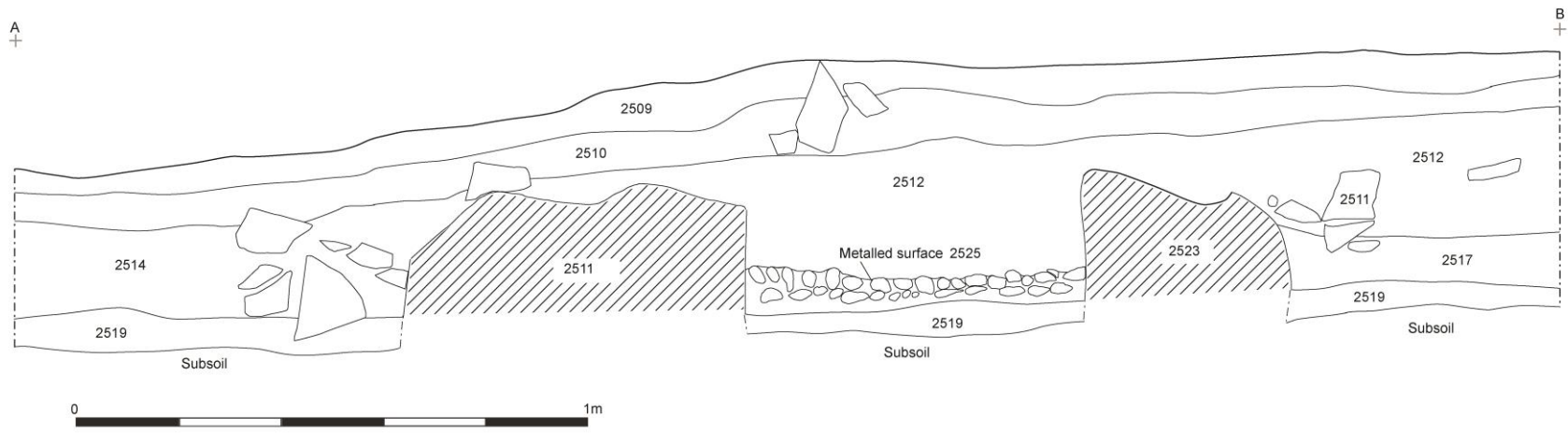

Figure 82: South facing section of Trench 25b

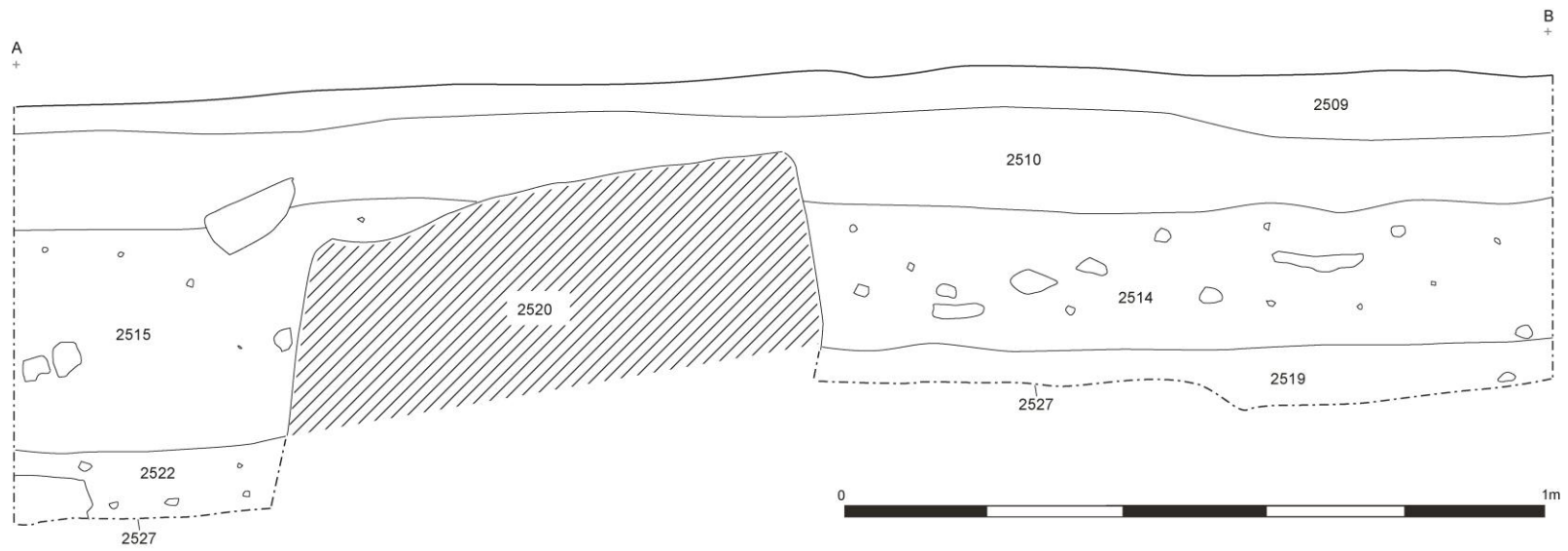

Figure 83: East facing section of Trench 25b

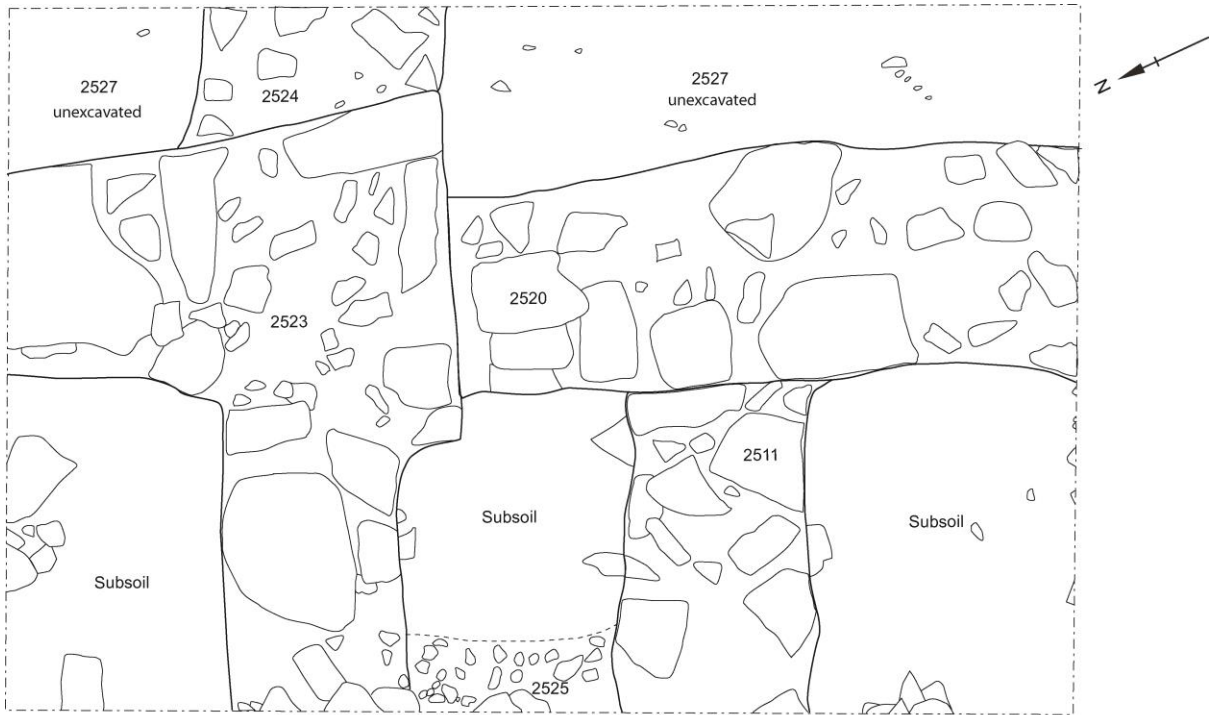

Figure 84: Post-excavation plan of Trench 25b

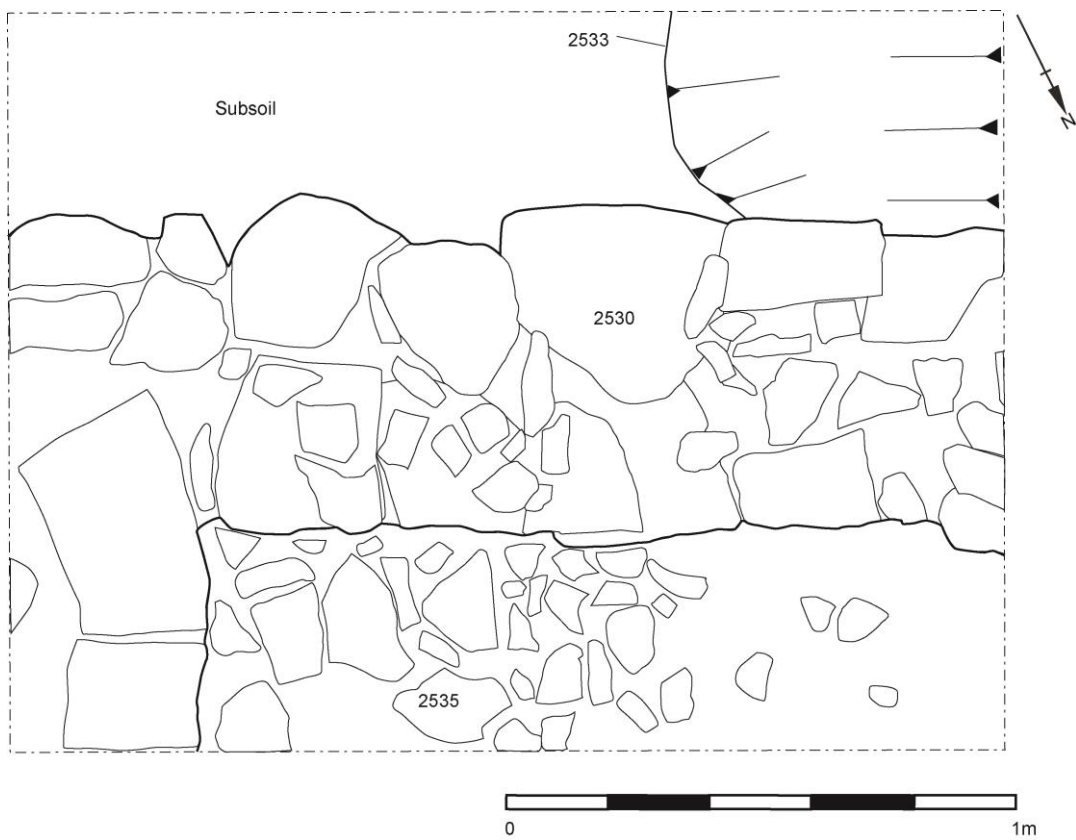

Figure 85: Post-excavation plan of Trench 25c

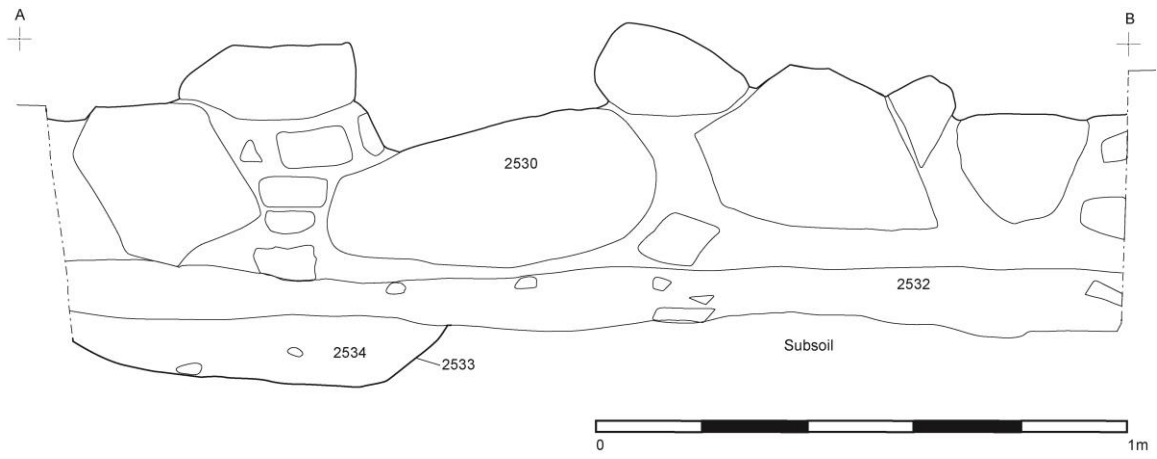

Figure 86: Trench 25c, west facing elevation of wall 2530

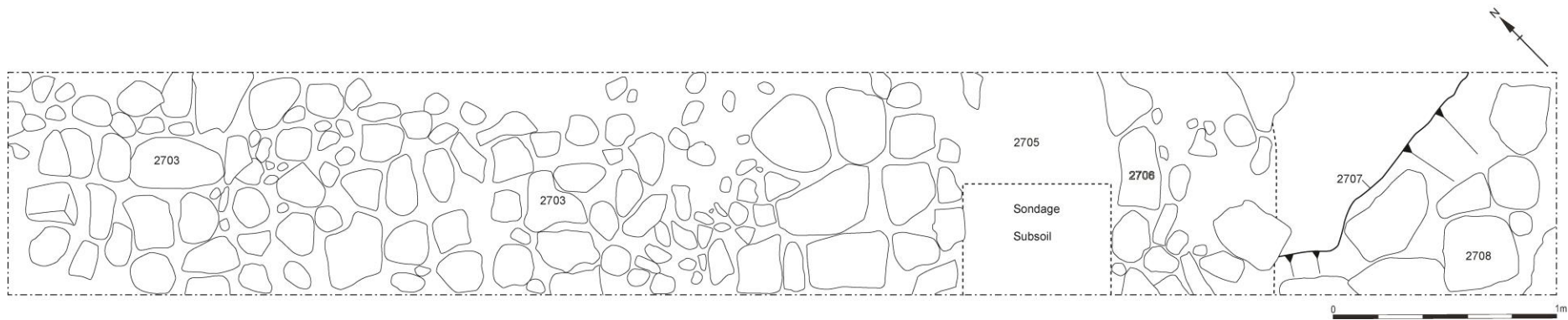

Figure 87: Post-excavation plan of Trench 27

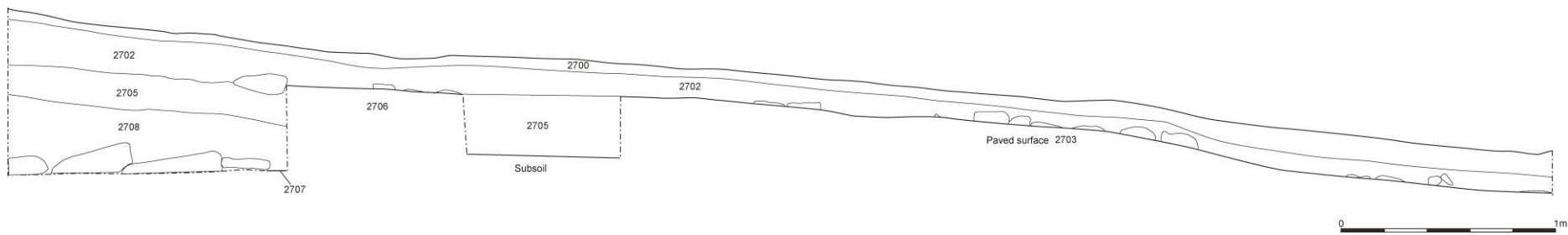

Figure 88: East-facing section of Trench 27

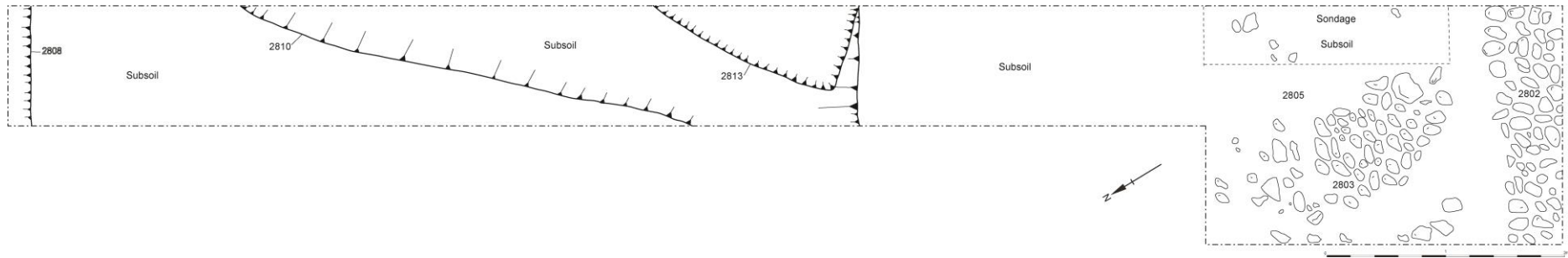

Figure 89: Post-excavation plan of Trench 28

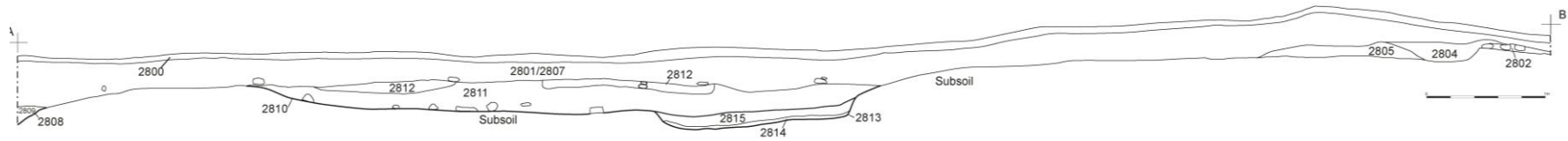

Figure 90: North facing section of Trench 28

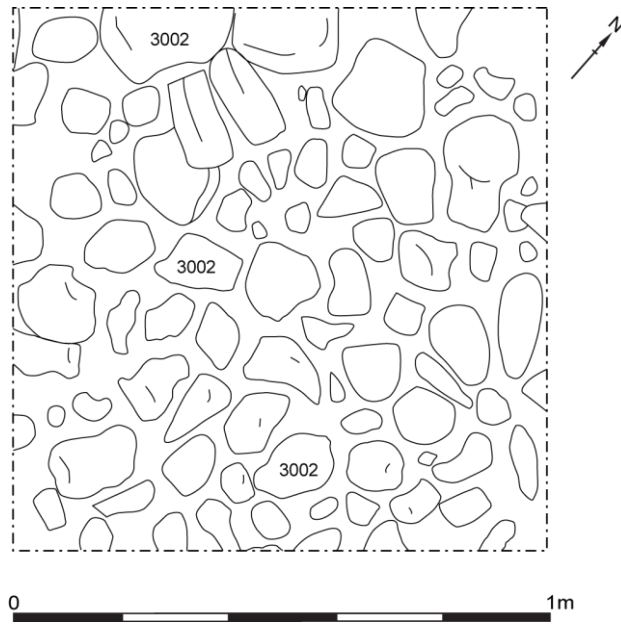

Figure 91: Post-excavation plan of Trench 30a

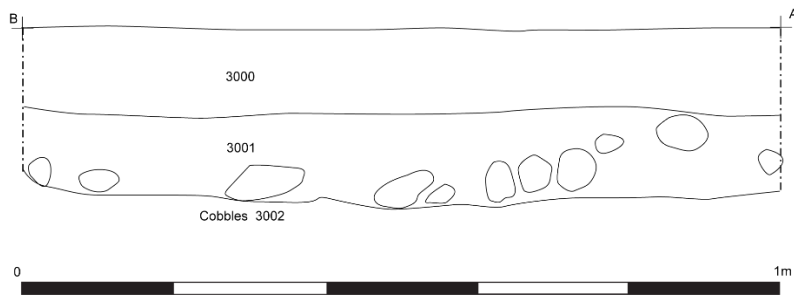

Figure 92: North facing section of Trench 30a

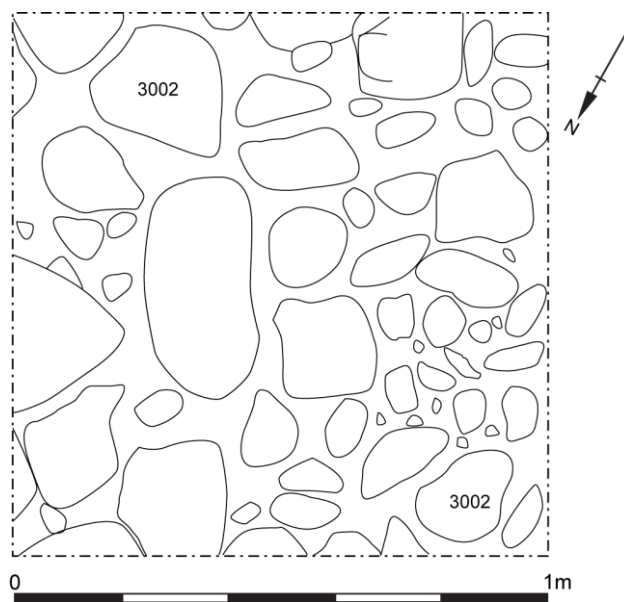

Figure 93: Post-excavation plan of Trench 30b



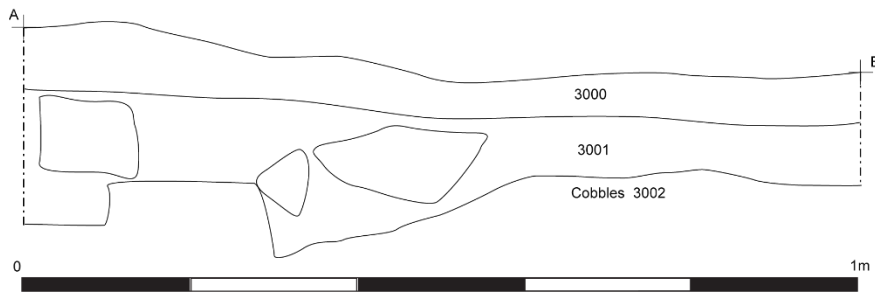

Figure 94: West facing section of Trench 30b

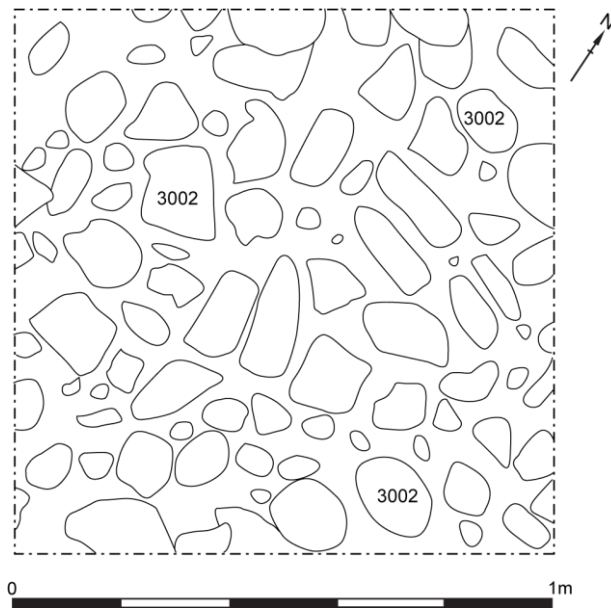

Figure 95: Post-excavation plan of Trench 30c

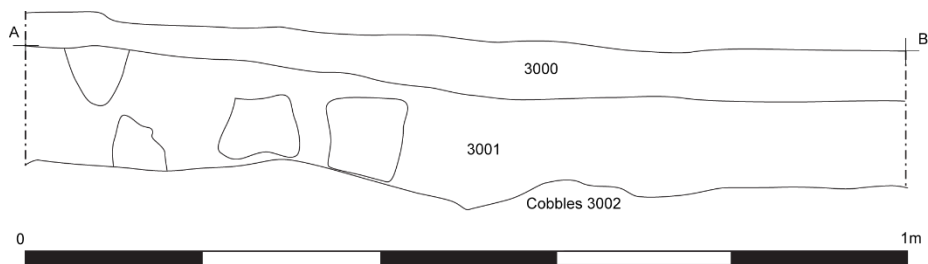

Figure 96: West facing section of Trench 30c

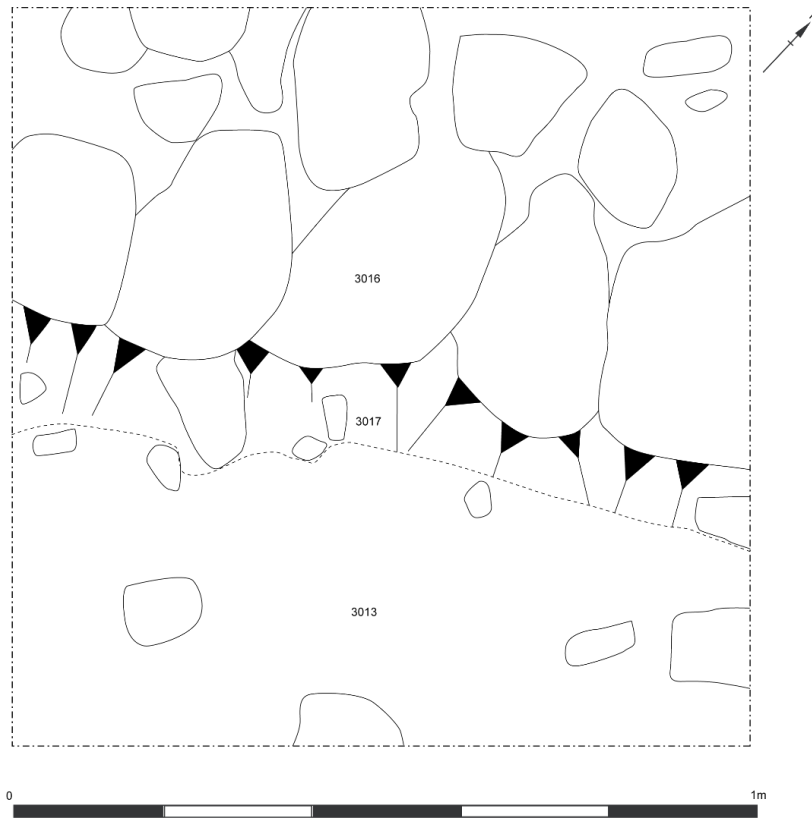

Figure 97: Post-excavation plan of Trench 30d

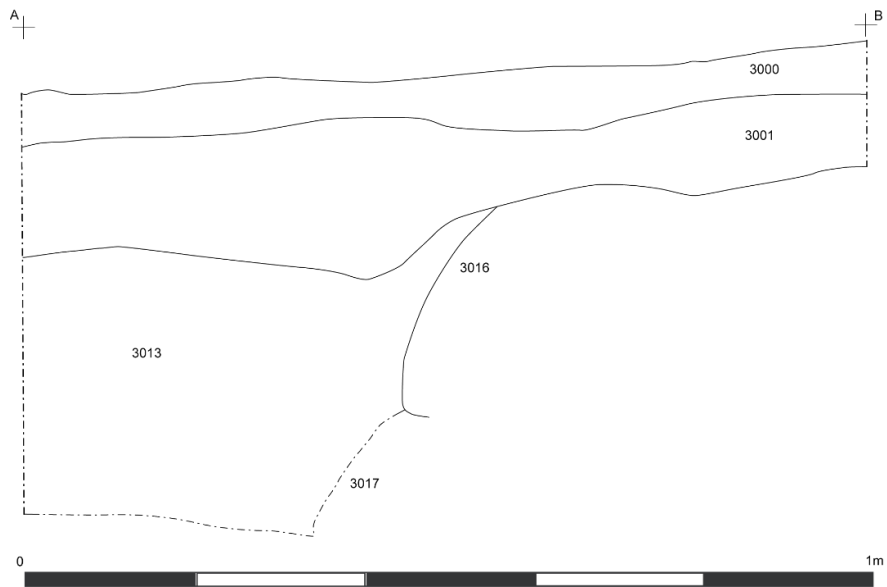

Figure 98: East facing section of Trench 30d

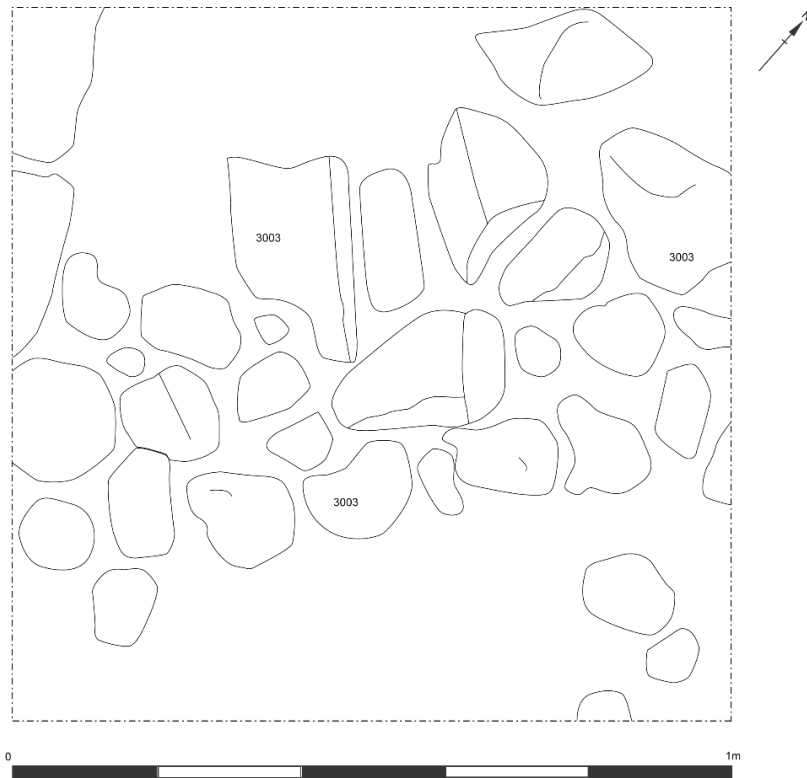

Figure 99: Post-excitation plan of Trench 30e

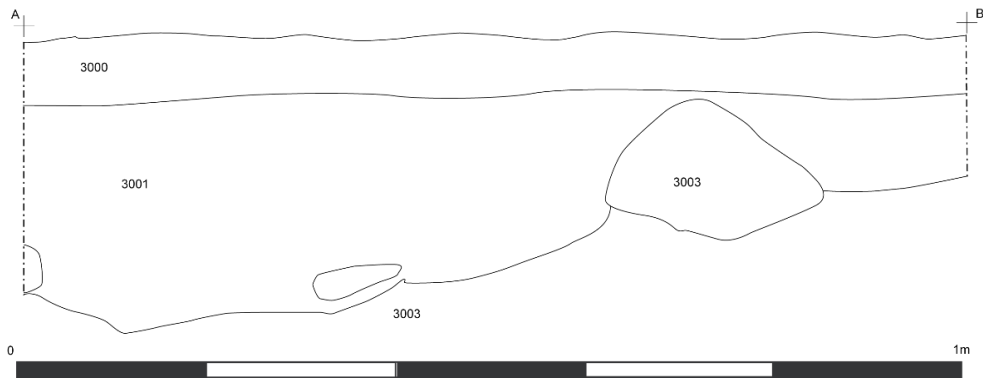

Figure 100: South facing section of Trench 30e

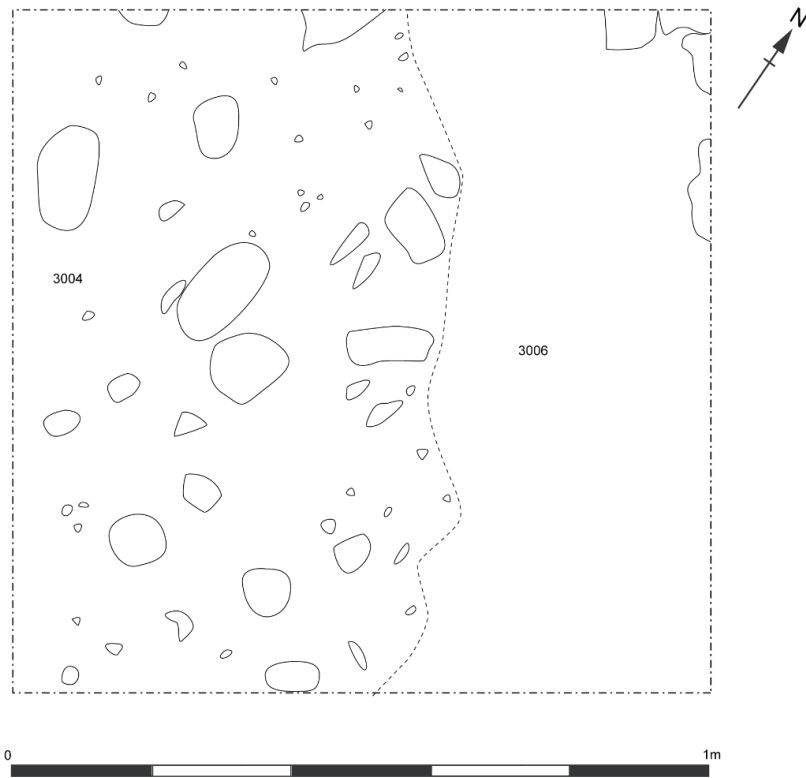

Figure 101: Mid-excavation plan of Trench 30f, showing surface 3004

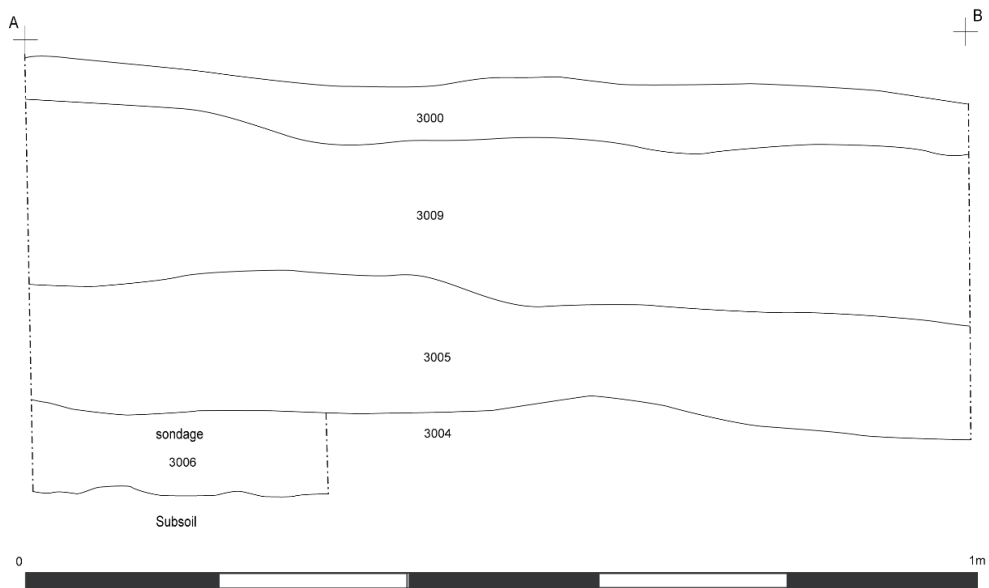

Figure 102: North facing section of Trench 30f

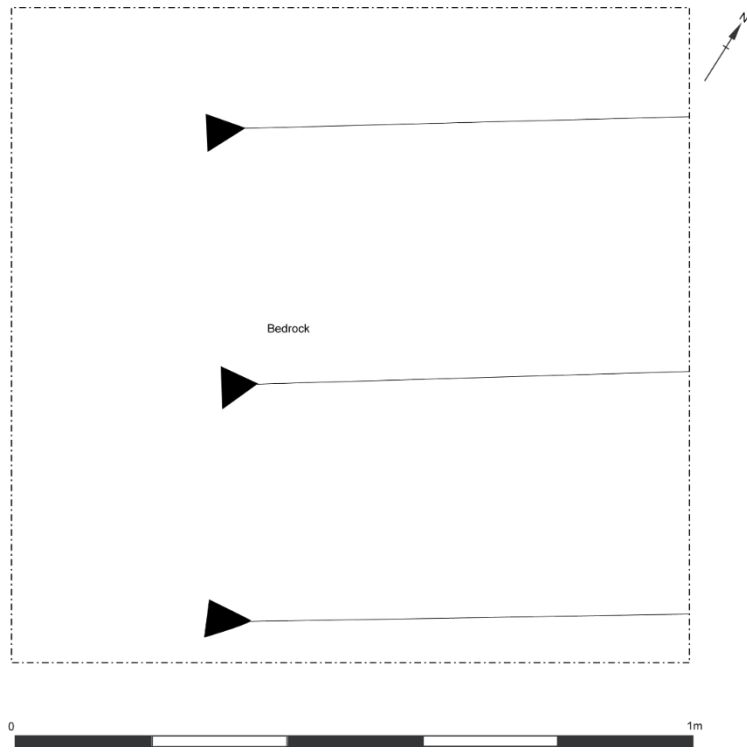

Figure 103: Post-excavation plan of Trench 30g

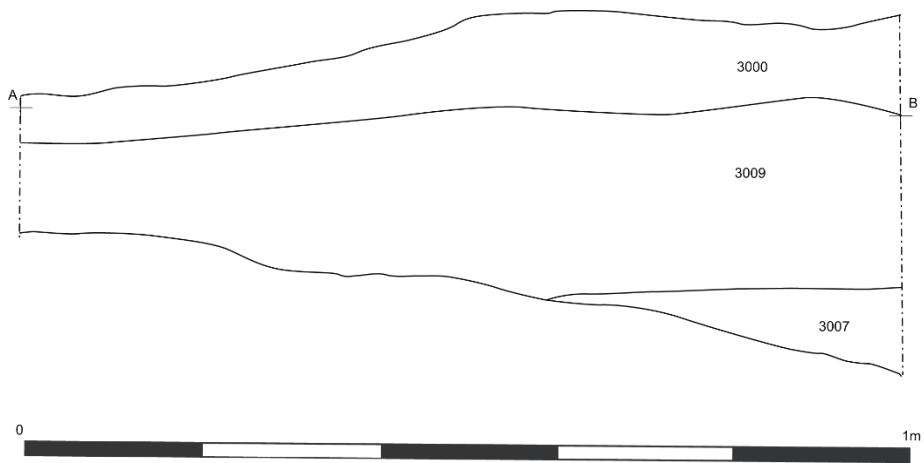

Figure 104: South facing section of Trench 30g

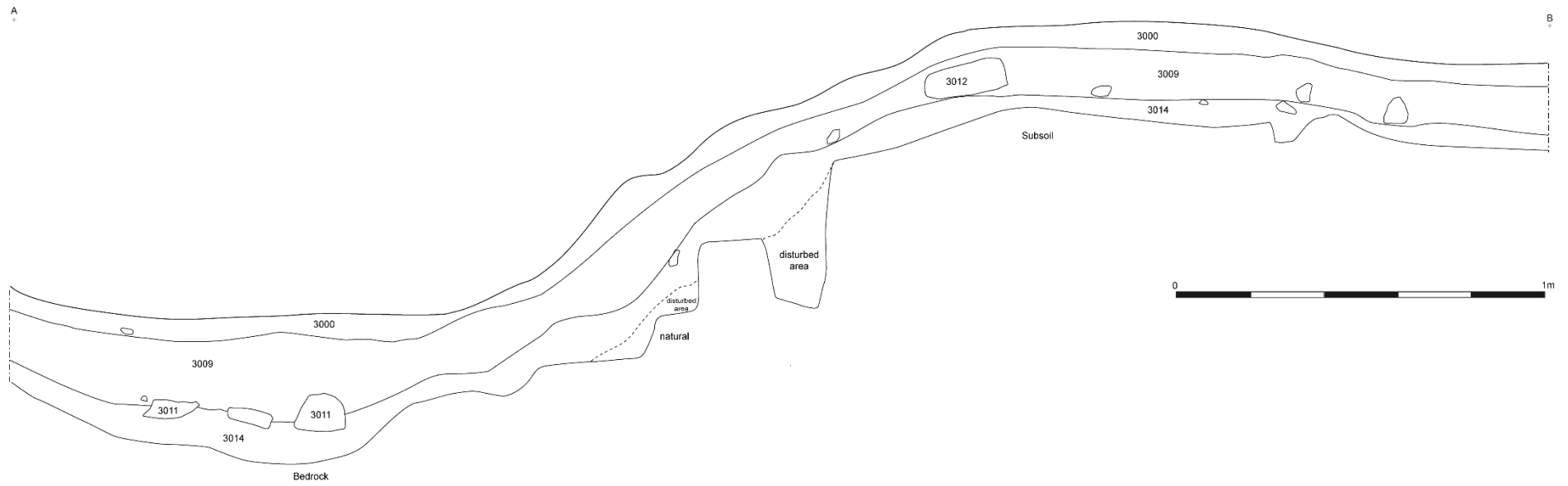

Figure 105: East facing section of Trench 30h

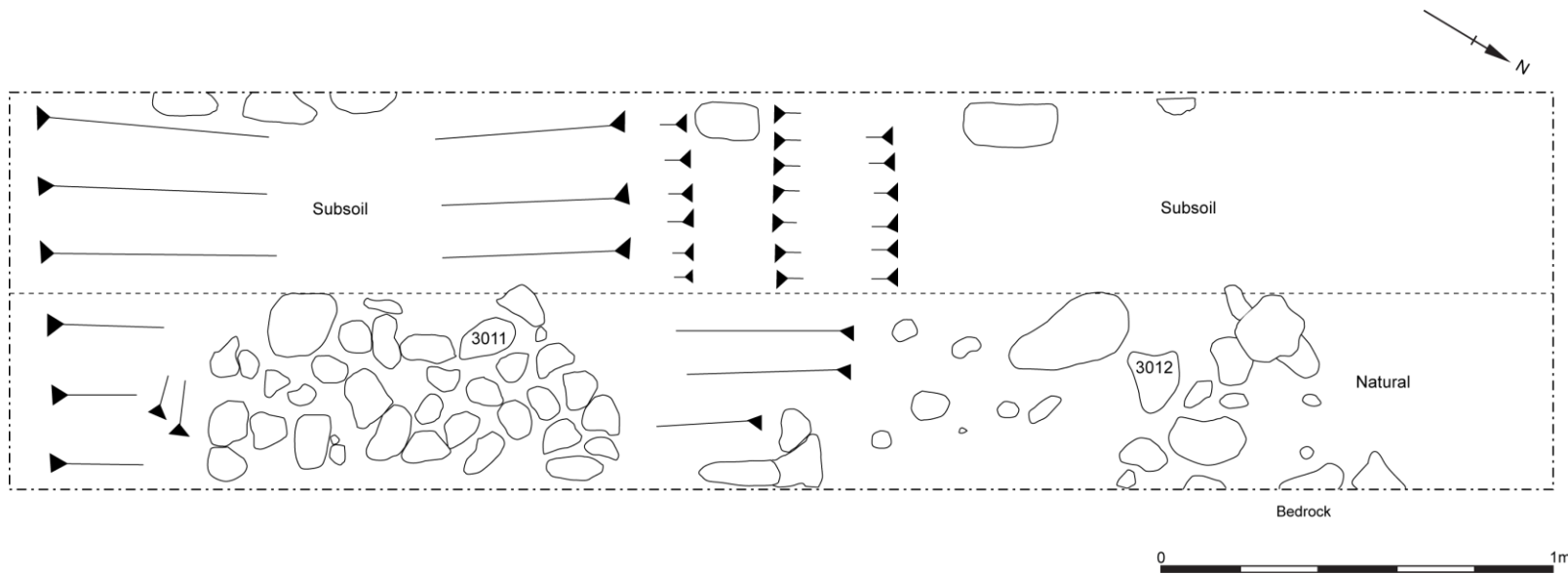

Figure 106: Post-excavation plan of Trench 30h

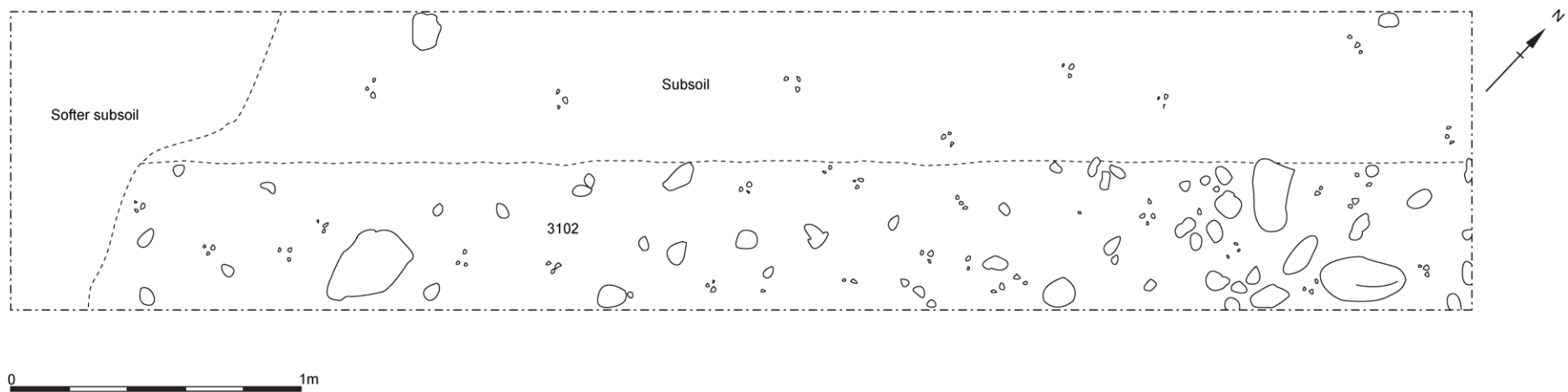

Figure 107: Post-excavation plan of Trench 31



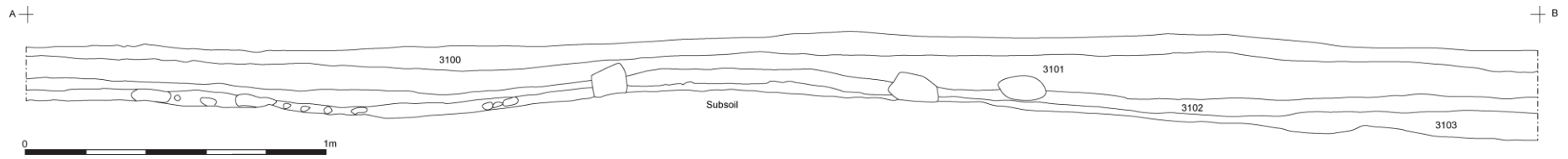

Figure 108: South facing section of Trench 31

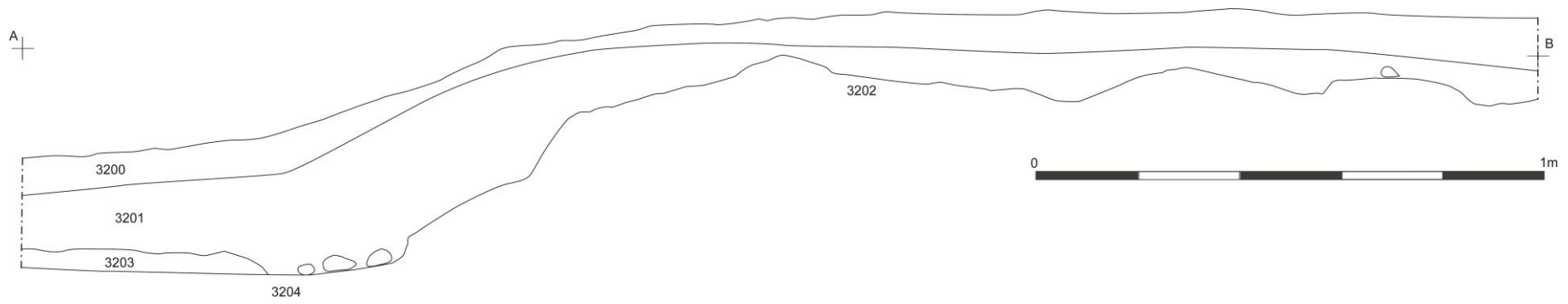

Figure 109: East facing section of Trench 32

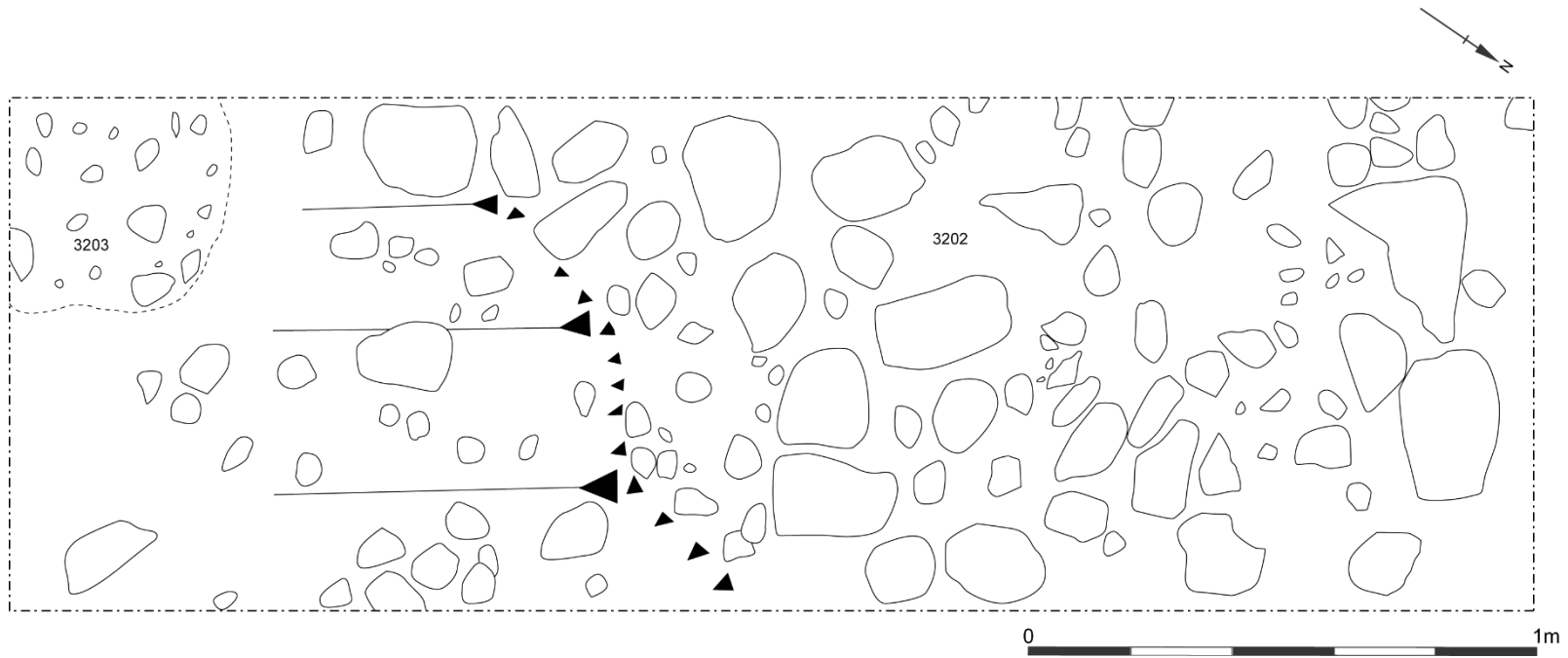
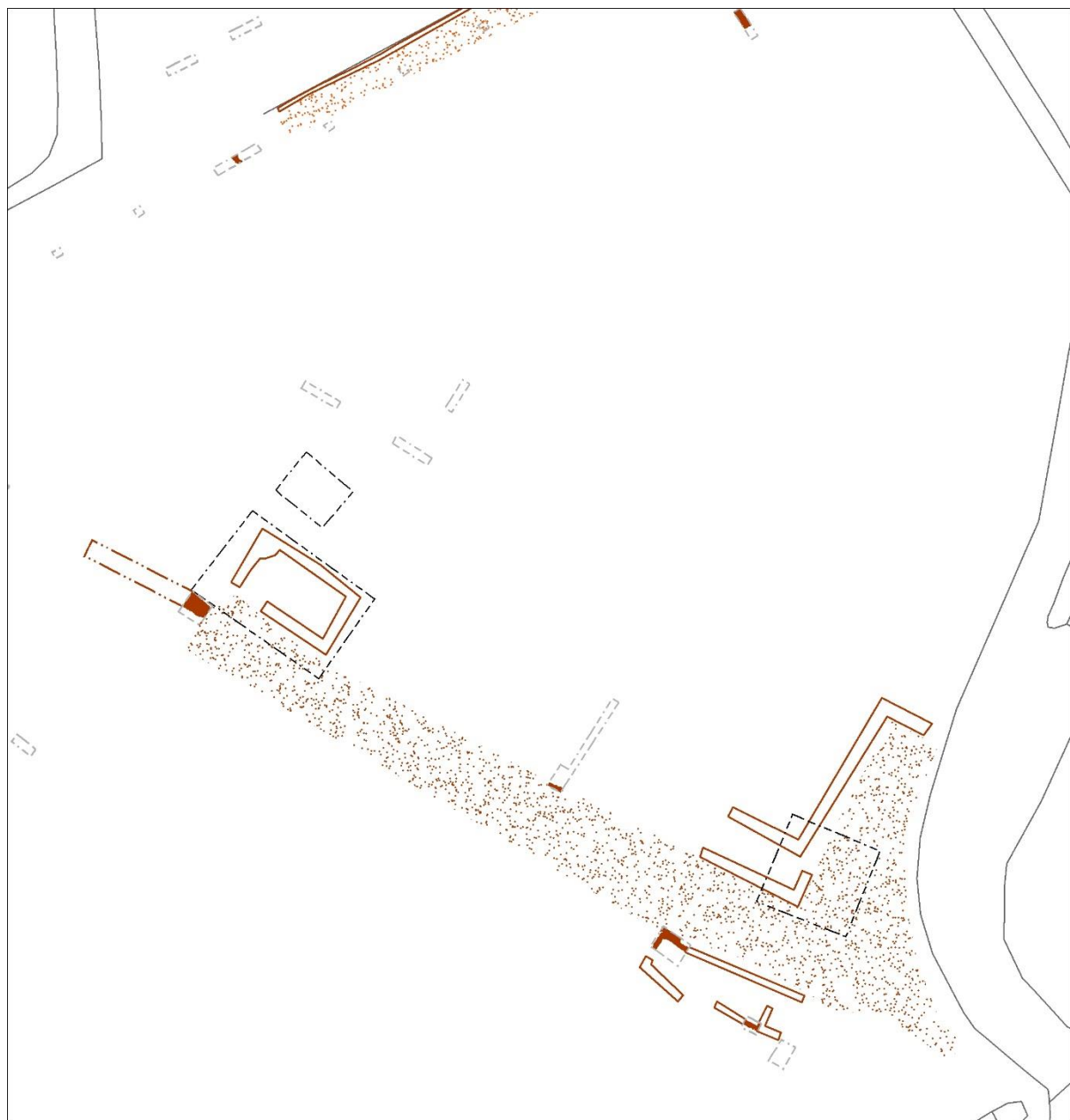

Figure 110: Post-excavation plan of Trench 32



0 10 20 40 Meters



**Legend**

- | Excavated archaeological anomalies   | Geophysical anomalies   |
|--|---|
| <span style="color: orange;">■</span> 17th century   | --- Drain   |
| <span style="color: green;">■</span> pre-17th century  | - - - Drip guillies   |
| <b>Excavation trenches</b>   | - · - · Cobbled pathway   |
| <span style="border: 1px dashed black; display: inline-block; width: 10px; height: 10px;"></span> Excavated 2014       | — Wall  |
| <span style="border: 1px dashed black; display: inline-block; width: 10px; height: 10px;"></span> Excavated Breen 2012 | <span style="color: orange;">· · · ·</span> Later 17th-century cobbled roadway  |
|  | <span style="color: green;">· · · ·</span> Earlier 17th-century cobbled roadway |

Figure 111: Plan showing suspected continuation of excavated features in Area T (produced by Dr Siobhan McDermott – CAF, after Breen 2012 and McHugh 2012)



0 5 10 20 Meters



**Legend**

- | Excavated archaeological anomalies  | Geophysical anomalies                                      |
|---|--|
| <span style="color: brown;">■</span> 17th century   | <span style="color: brown;">---</span> Drain               |
| <span style="color: green;">■</span> pre-17th century   | <span style="color: green;">---</span> Drip guillies       |
| <span style="border: 1px dashed gray; display: inline-block; width: 10px; height: 10px;"></span> Excavated Trenches | <span style="color: brown;">---</span> Possible pathway    |
|   | <span style="color: brown;">—</span> Wall                  |
|   | <span style="color: brown;">⋯</span> Cobbled roadway       |
|   | <span style="color: brown;">⋯</span> Crushed brick walkway |

Figure 112: Plan showing suspected continuation of excavated features in Area G (produced by Dr Siobhan McDermott – CAF, after McHugh 2012 and Mussen 2012)

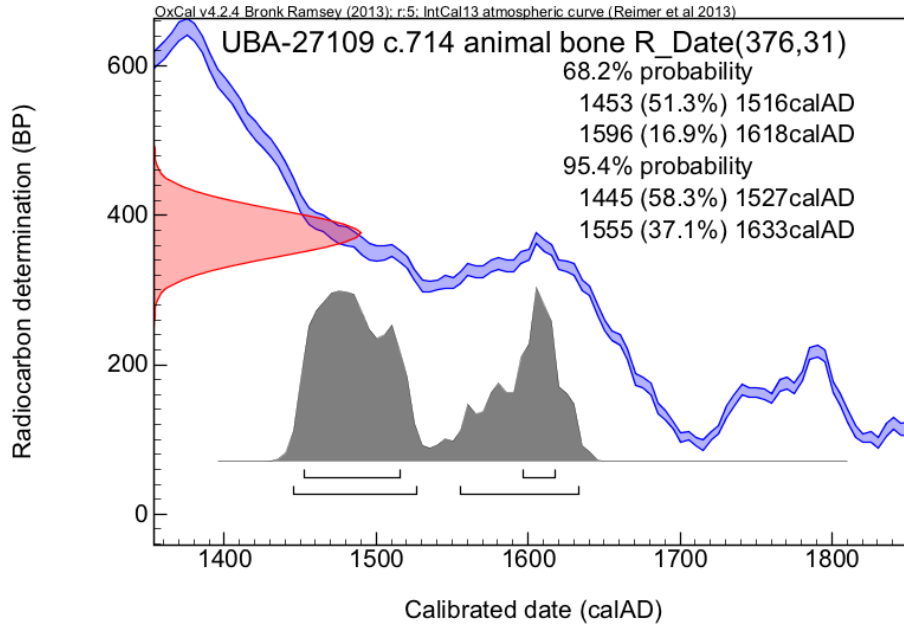

Figure 113: Calibration of UBA-27109

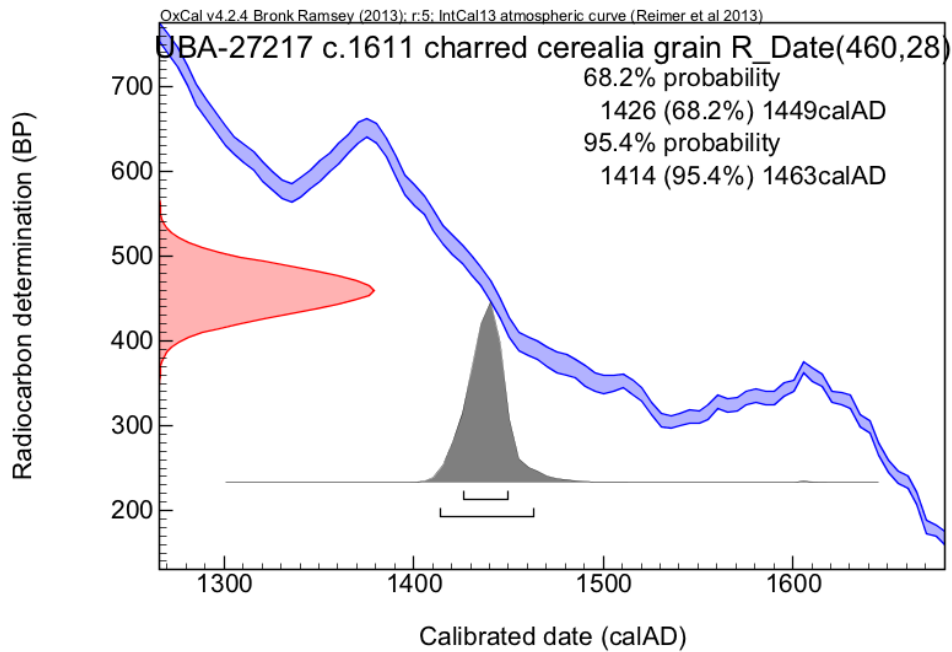

Figure 114: Calibration of UBA-27217

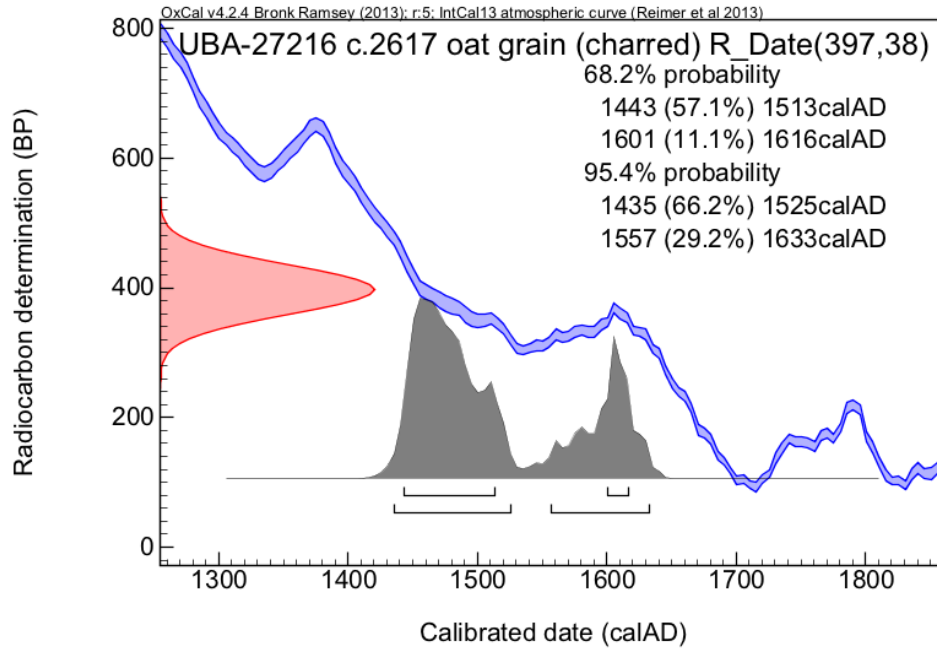

Figure 115: Calibration of UBA-27216

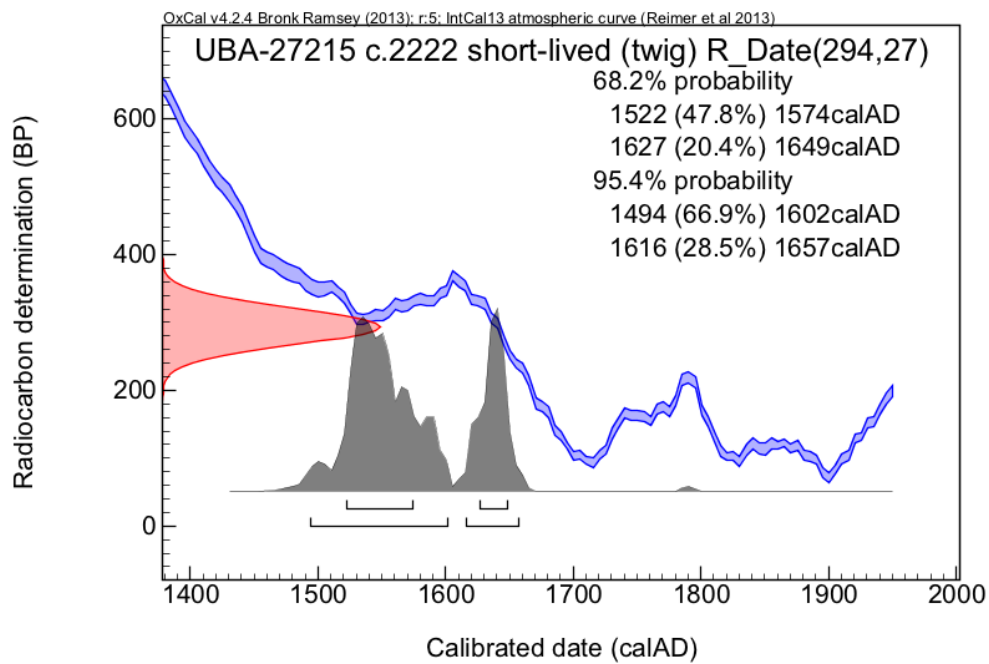

Figure 116: Calibration of UBA-27215

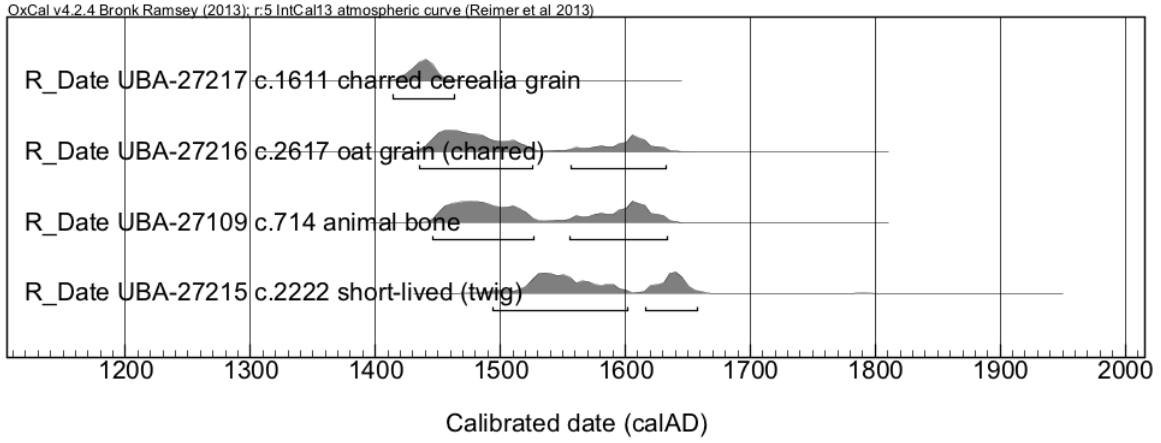

Figure 117: Graph showing calibrated radiocarbon dates of UBA-27217, UBA-27216, UBA-27109 and UBA-27215